

CC-Link IE Field Network Remote Module FB Library Reference Manual

Applicable modules:

NZ2GF2B-60AD4, NZ2GF2B-60DA4,
NZ2GF2B1-16D, NZ2GF2B1-16T, NZ2GF2B1-16TE,
NZ2GFCF-D62PD2

<CONTENTS>

Reference Manual Revision History	2
1. Overview	3
1.1. Overview of the FB Library.....	3
1.2. Function of the FB Library	3
1.3. System Configuration Example	4
1.4. Creating Interlock Programs.....	5
1.4.1. Transient Transmission Interlock Program.....	5
1.5. Relevant Manuals	6
1.6. Note	6
2. Details of the FB Library.....	7
2.1. M+NZ2GF_ReadRemoteBufMemory (Read remote buffer memory).....	7
2.2. M+NZ2GF_WriteRemoteBufMemory (Write remote buffer memory).....	13
2.3. M+NZ2GF_ReadExtModuleCode (Read extension module identification code).....	18
2.4. M+NZ2GF_ReadOutputOnTimes (Read number of ON times integration value).....	23
2.5. M+NZ2GF_OutputOnTimesTotalClr (Number of ON times integration value clear)	29
2.6. M+NZ2GF_ParameterInfoClr (Parameter information initialization)	34
2.7. M+NZ2GF_ErrorHistoryClr (Error history clear)	39
2.8. M+NZ2GF_ModuleWorkingInfoClr (Module operation information initialization).....	44
Appendix 1. FB Library Application Examples	49

Reference Manual Revision History

Reference Manual Number	Date	Description
FBM-M094-A	2013/07/15	First edition

1. Overview

1.1. Overview of the FB Library

This FB Library is for using the CC-Link IE Field Network Remote Module.

1.2. Function of the FB Library

Item	Description
M+NZ2GF_ReadRemoteBufMemory	Reads a value from a specified remote buffer memory.
M+NZ2GF_WriteRemoteBufMemory	Writes a value to a specified remote buffer memory.
M+NZ2GF_ReadExtModuleCode	Reads the identification code of a specified extension module.
M+NZ2GF_ReadOutputOnTimes	Reads the number of ON times integration values Y0 to YF of a specified extension module.
M+NZ2GF_OutputOnTimesTotalClr	Clears the number of ON times integration values Y0 to YF of a specified extension module.
M+NZ2GF_ParameterInfoClr	Initializes the parameter information.
M+NZ2GF_ErrorHistoryClr	Clears the error history.
M+NZ2GF_ModuleWorkingInfoClr	Initializes the module operation information.

1.3. System Configuration Example

The following shows the system configuration when the digital-analog converter module (NZ2GF2B-60DA4) and the extension output module (NZ2EX2B1-16T) are used as the remote device stations.

(1) Q-series system configuration

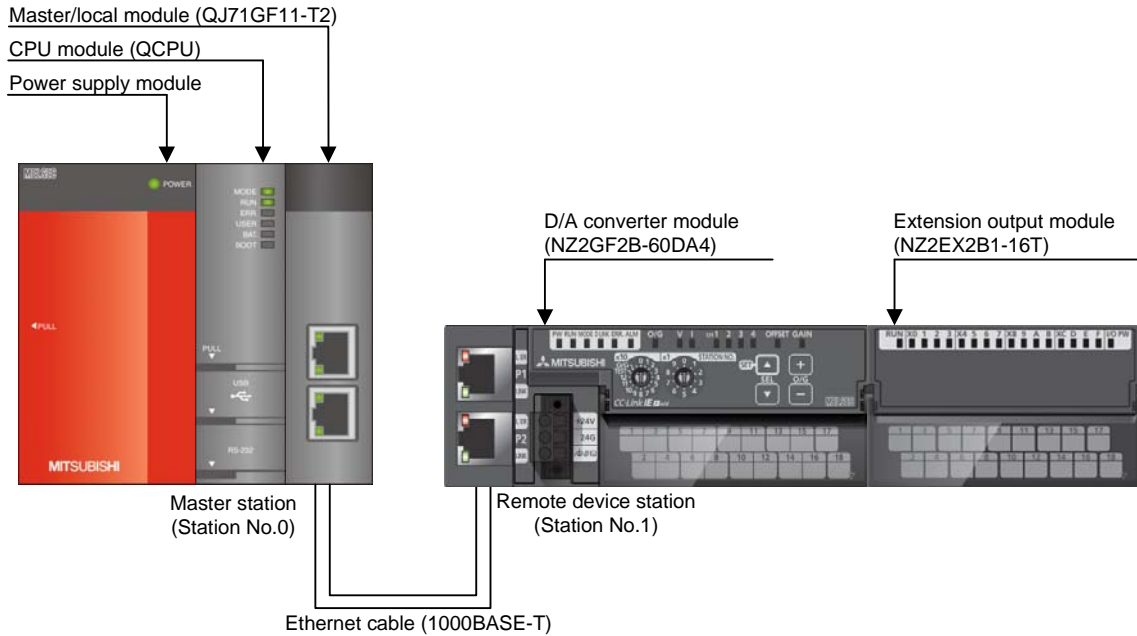

(2) L-series system configuration

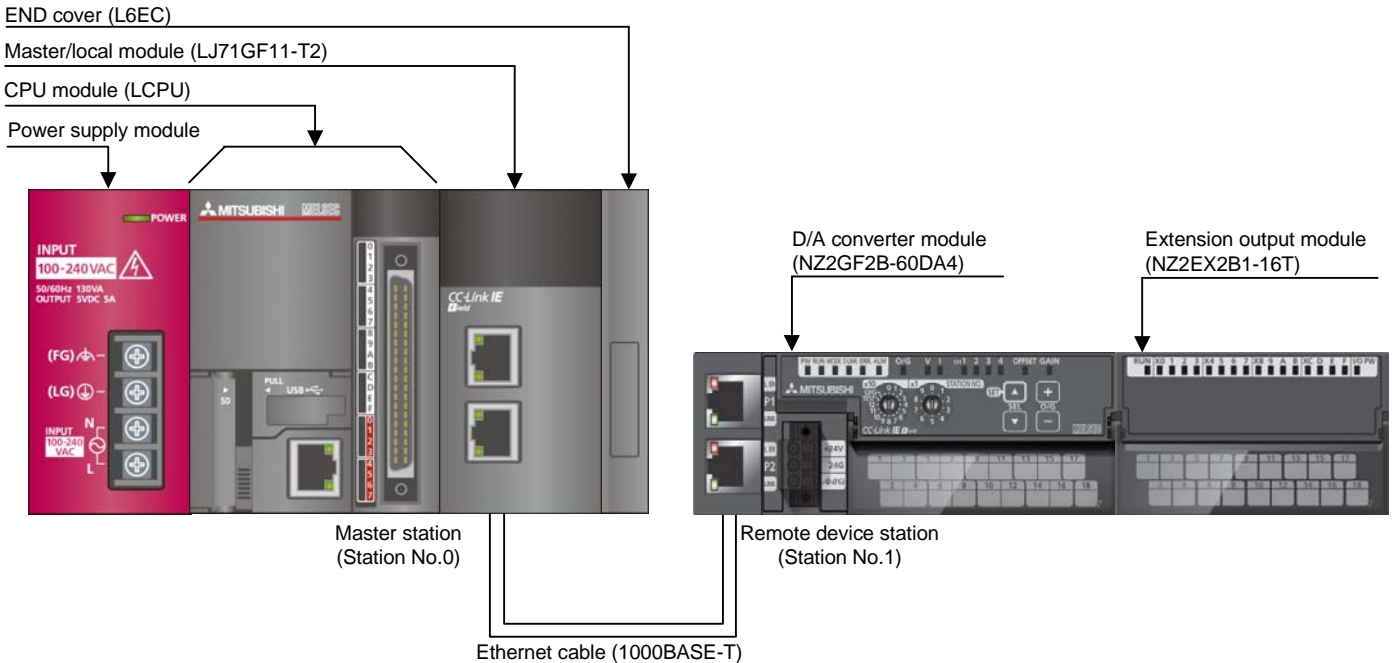

1.4. Creating Interlock Programs

Interlock programs must be created for the FBs. The following is an example of an interlock program.
(Set a corresponding FB between MC and MCR instructions.)

1.4.1. Transient Transmission Interlock Program

Use link special relay (SB) and link special register (SW) to create an interlock for transient transmission program.

- Own station baton pass status (SB0047)
- Baton pass status (each station) (SW00A0 to SW00A7)

Example: Interlock example (station No.1)

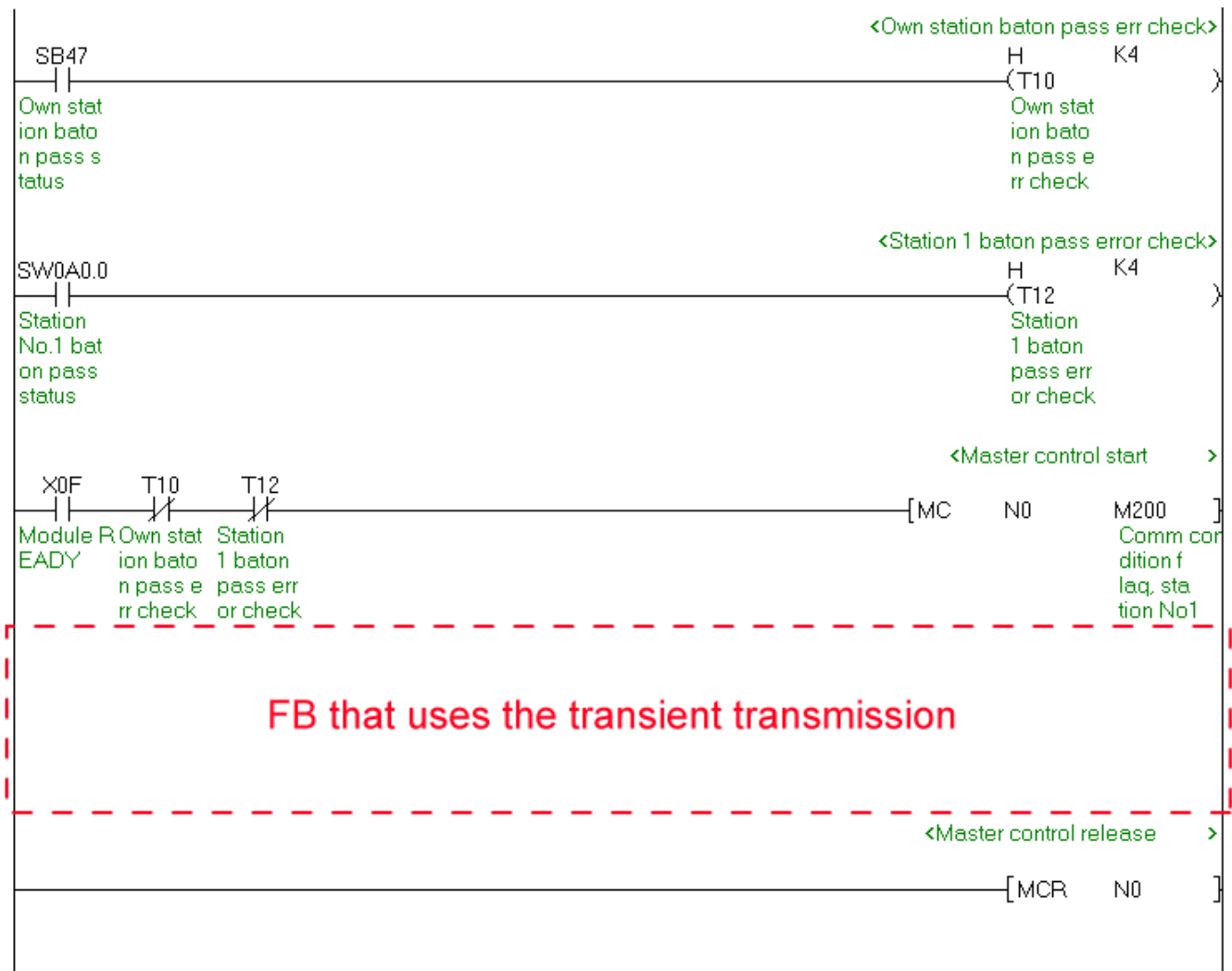

*1 All the FBs in this manual use the transient transmission.

1.5. Relevant Manuals

CC-Link IE Field Network Analog-Digital Converter Module User's Manual

CC-Link IE Field Network Digital-Analog Converter Module User's Manual

CC-Link IE Field Network Remote I/O Module User's Manual

CC-Link IE Field Network High-Speed Counter Module User's Manual

MELSEC-Q CC-Link IE Field Network Master/Local Module User's Manual

MELSEC-L CC-Link IE Field Network Master/Local Module User's Manual

QCPU User's Manual (Hardware Design, Maintenance and Inspection)

MELSEC-L CPU Module User's Manual (Hardware Design, Maintenance and Inspection)

GX Works2 Version 1 Operating Manual (Common)

GX Works2 Version 1 Operating Manual (Simple Project, Function Block)

1.6. Note

Please make sure to read user's manuals for the corresponding products before using the products.

2. Details of the FB Library

2.1. M+NZ2GF_ReadRemoteBufMemory (Read remote buffer memory)

FB Name

M+NZ2GF_ReadRemoteBufMemory

Function Overview

Item	Description																								
Function overview	Reads a value from a specified remote buffer memory.																								
Symbol	<div style="border: 1px solid black; padding: 10px; margin: 10px auto; width: fit-content;"> <p style="text-align: center; margin: 0;">M+NZ2GF_ReadRemoteBufMemory</p> <table style="width: 100%; border-collapse: collapse;"> <tr> <td style="width: 30%; border: none;">Execution command</td> <td style="width: 30%; border: none;">B : FB_EN</td> <td style="width: 30%; border: none;">FB_ENO : B</td> <td style="width: 10%; border: none;">Execution status</td> </tr> <tr> <td style="border: none;">Module start XY address</td> <td style="border: none;">W : i_Start_IO_No</td> <td style="border: none;">FB_OK : B</td> <td style="border: none;">Completed without error</td> </tr> <tr> <td style="border: none;">Station No.</td> <td style="border: none;">W : i_Station_No</td> <td style="border: none;">o_ReadData : W</td> <td style="border: none;">Read data</td> </tr> <tr> <td style="border: none;">Own station channel</td> <td style="border: none;">W : i_CH_No</td> <td style="border: none;">FB_ERROR : B</td> <td style="border: none;">Error flag</td> </tr> <tr> <td style="border: none;">Remote buffer address</td> <td style="border: none;">W : i_Address</td> <td style="border: none;">ERROR_ID : W</td> <td style="border: none;">Error code</td> </tr> <tr> <td style="border: none;">Reading points</td> <td style="border: none;">W : i_ReadPoint</td> <td></td> <td></td> </tr> </table> </div>	Execution command	B : FB_EN	FB_ENO : B	Execution status	Module start XY address	W : i_Start_IO_No	FB_OK : B	Completed without error	Station No.	W : i_Station_No	o_ReadData : W	Read data	Own station channel	W : i_CH_No	FB_ERROR : B	Error flag	Remote buffer address	W : i_Address	ERROR_ID : W	Error code	Reading points	W : i_ReadPoint		
Execution command	B : FB_EN	FB_ENO : B	Execution status																						
Module start XY address	W : i_Start_IO_No	FB_OK : B	Completed without error																						
Station No.	W : i_Station_No	o_ReadData : W	Read data																						
Own station channel	W : i_CH_No	FB_ERROR : B	Error flag																						
Remote buffer address	W : i_Address	ERROR_ID : W	Error code																						
Reading points	W : i_ReadPoint																								
Applicable hardware and software	CC-Link IE Field Network remote module	<table border="1" style="width: 100%; border-collapse: collapse;"> <thead> <tr> <th style="width: 30%;">Category</th> <th>Model</th> </tr> </thead> <tbody> <tr> <td>Analog</td> <td>NZ2GF2B-60AD4, NZ2GF2B-60DA4</td> </tr> <tr> <td>I/O</td> <td>NZ2GF2B1-16D, NZ2GF2B1-16T, NZ2GF2B1-16TE</td> </tr> <tr> <td>Counter</td> <td>NZ2GF2CF-D62PD2</td> </tr> </tbody> </table>	Category	Model	Analog	NZ2GF2B-60AD4, NZ2GF2B-60DA4	I/O	NZ2GF2B1-16D, NZ2GF2B1-16T, NZ2GF2B1-16TE	Counter	NZ2GF2CF-D62PD2															
	Category	Model																							
	Analog	NZ2GF2B-60AD4, NZ2GF2B-60DA4																							
I/O	NZ2GF2B1-16D, NZ2GF2B1-16T, NZ2GF2B1-16TE																								
Counter	NZ2GF2CF-D62PD2																								
CC-Link IE Field Network module	CC-Link IE Field Network master/local module *1 *1 The first five digits of the serial number are "14102" or later.																								
CPU module	<table border="1" style="width: 100%; border-collapse: collapse;"> <thead> <tr> <th style="width: 30%;">Series</th> <th>Model</th> </tr> </thead> <tbody> <tr> <td>MELSEC-Q Series *1</td> <td>Universal model *2</td> </tr> <tr> <td>MELSEC-L Series</td> <td>LCPU *3</td> </tr> </tbody> </table> <p>*1 Not applicable to QCPU (A mode) *2 The first five digits of the serial number are "12012" or later. *3 The first five digits of the serial number are "13012" or later.</p>	Series	Model	MELSEC-Q Series *1	Universal model *2	MELSEC-L Series	LCPU *3																		
Series	Model																								
MELSEC-Q Series *1	Universal model *2																								
MELSEC-L Series	LCPU *3																								

Item	Description							
	Engineering software	GX Works2 *1 <table border="1"> <thead> <tr> <th>Language</th> <th>Software version</th> </tr> </thead> <tbody> <tr> <td>English version</td> <td>Version1.24A or later</td> </tr> <tr> <td>Chinese version</td> <td>Version1.49B or later</td> </tr> </tbody> </table> *1 For software versions applicable to the modules used, refer to "Relevant manuals".	Language	Software version	English version	Version1.24A or later	Chinese version	Version1.49B or later
Language	Software version							
English version	Version1.24A or later							
Chinese version	Version1.49B or later							
Programming language	Ladder							
Number of steps	277 steps (for MELSEC-Q series universal model CPU) * The number of steps of the FB in a program depends on the CPU model that is used and input and output definition.							
Function description	<p>1) By turning ON FB_EN (Execution command), the word data of the points set in i_ReadPoint (Reading points) is read from the remote buffer memory with the address set in i_Address (Remote buffer address).</p> <p>The values read from the remote buffer memory are stored in devices starting from the device specified in o_ReadData (Read data). The stored word data is equivalent to the points set in i_ReadPoint (Reading points).</p> <p>(For example, when the remote buffer address is set to 1000H, the reading points are set to 10 in the input label, the read data is set to D100 in the output label, the values of the specified remote buffer memory are stored in D100 to D109.)</p> <div style="text-align: center;"> <pre> graph LR subgraph Remote_buffer_memory [Remote buffer memory] R1[1000H] R2[1001H] R3[...] R4[...] R5[1009H] end subgraph Read_data [Read data] D1[D100] D2[D101] D3[...] D4[...] D5[D109] end R1 -- Read --> D1 R2 -- Read --> D2 R3 -- Read --> D3 R4 -- Read --> D4 R5 -- Read --> D5 </pre> </div>							
	<p>2) When FB_EN (Execution command) is turned OFF during the remote buffer memory reading processing, the values read previously remain.</p> <p>3) When the CC-Link IE Field Network error occurs, the FB_ERROR (Error flag) output turns ON and processing is interrupted, and the error code is stored in ERROR_ID (Error code). Refer to the error code explanation section for details.</p>							
Compiling method	Macro type							

Item	Description
Restrictions and precautions	<ol style="list-style-type: none"> 1) The FB does not include error recovery processing. Program the error recovery processing separately in accordance with the required system operation. 2) The FB cannot be used in an interrupt program. 3) This FB uses the REMFR instruction. When operating this FB together with other FBs or using the REMFR or REMTO instruction in the ladder program, make sure that the channels used by the own station are not duplicated. 4) This FB requires multiple scans from ON of FB_EN (Execution command) to ON of FB_OK (Completed without error). 5) A continuous area for the read data points is required for a device to which the read value of the remote buffer memory is stored. 6) This FB uses index registers Z7 to Z9. Please do not use these index registers in an interrupt program. 7) This FB uses the transient transmission. An interlock program for the transient transmission is required. For the interlock program, refer to "1.4.1 Transient Transmission Interlock Program". 8) Every input must be provided with a value for proper FB operation.
FB operation type	Real-time execution
Application example	Refer to "Appendix 1. FB Library Application Examples".
Timing chart	<div style="display: flex; justify-content: space-between;"> <div style="width: 48%;"> <p>[When operation completes without error]</p> </div> <div style="width: 48%;"> <p>[When an error occurs]</p> </div> </div> <p>*1. Turns ON only for one scan.</p> <p>*2. The read data is updated every time the reading processing is completed.</p>

Item	Description
Relevant manuals	CC-Link IE Field Network Analog-Digital Converter Module User's Manual CC-Link IE Field Network Digital-Analog Converter Module User's Manual CC-Link IE Field Network Remote I/O Module User's Manual CC-Link IE Field Network High-Speed Counter Module User's Manual MELSEC-Q CC-Link IE Field Network Master/Local Module User's Manual MELSEC-L CC-Link IE Field Network Master/Local Module User's Manual QCPU User's Manual (Hardware Design, Maintenance and Inspection) MELSEC-L CPU Module User's Manual (Hardware Design, Maintenance and Inspection) GX Works2 Version 1 Operating Manual (Common) GX Works2 Version 1 Operating Manual (Simple Project, Function Block)

Error codes

●Error code list

Error code	Description	Action
60 (Decimal)	The specified station number is not valid. The station number is not within the range of 1 to 120.	Please try again after confirming the setting.
D000 to DAF9 (Hexadecimal)	A CC-Link IE Field Network error has occurred.	For details, refer to the error code list of MELSEC-Q/MELSEC-L CC-Link IE Field Network Master/Local Module User's Manual.

Labels

●Input labels

Name (Comment)	Label name	Data type	Setting range	Description
Execution command	FB_EN	Bit	ON, OFF	ON: The FB is activated. OFF: The FB is not activated.
Module start XY address	i_Start_IO_No	Word	Depends on the I/O point range of the CPU. For details, refer to the CPU user's manual.	Specify the starting XY address (in hexadecimal) where the CC-Link IE Field Network master/local module is mounted or connected. (For example, enter H10 for X10.)
Station No.	i_Station_No	Word	1 to 120	Specify the station number of the target station.
Own station channel	i_CH_No	Word	1 to 32	Specify the channel for accessing other stations from the own station.
Remote buffer address	i_Address	Word	Depends on the remote buffer memory of the target module. For details, refer to the user's manual of the target module.	Specify the starting address (in hexadecimal) of the remote buffer memory from which the values are read.
Reading points	i_ReadPoint	Word	1 to 240	Specify the reading points.

●Output labels

Name (Comment)	Label name	Data type	Initial value	Description
Execution status	FB_ENO	Bit	OFF	ON: During FB execution OFF: During FB stopped
Completed without error	FB_OK	Bit	OFF	When ON, it indicates that reading the value from the specified remote buffer memory is completed.
Read data	o_ReadData	Word	0	Specify a device that stores the value read from the remote buffer memory.
Error flag	FB_ERROR	Bit	OFF	When ON, it indicates that an error has occurred.
Error code	ERROR_ID	Word	0	FB error code output.

FB Version Upgrade History

Version	Date	Description
1.00A	2013/07/15	First edition

Note

This chapter includes information related to the function block.

It does not include information on restrictions of use such as combination with modules or programmable controller CPUs.

Please make sure to read user's manuals for the corresponding products before using the products.

2.2. M+NZ2GF_WriteRemoteBufMemory (Write remote buffer memory)

FB Name

M+NZ2GF_WriteRemoteBufMemory

Function Overview

Item	Description									
Function overview	Writes a value to a specified remote buffer memory.									
Symbol	<div style="display: flex; align-items: center; justify-content: center;"> <div style="margin-right: 20px;"> <p>Execution command — B : FB_EN</p> <p>Module start XY address — W : i_Start_IO_No</p> <p>Station No. — W : i_Station_No</p> <p>Own station channel — W : i_CH_No</p> <p>Remote buffer address — W : i_Address</p> <p>Writing points — W : i_WritePoint</p> <p>Write data — W : i_WriteData</p> </div> <div style="border: 1px solid black; padding: 10px; text-align: center;"> <p>M+NZ2GF_WriteRemoteBufMemory</p> </div> <div style="margin-left: 20px;"> <p>FB_ENO : B — Execution status</p> <p>FB_OK : B — Completed without error</p> <p>FB_ERROR : B — Error flag</p> <p>ERROR_ID : W — Error code</p> </div> </div>									
Applicable hardware and software	CC-Link IE Field Network remote module	<table border="1" style="width: 100%; border-collapse: collapse;"> <thead> <tr> <th style="width: 30%;">Category</th> <th>Model name</th> </tr> </thead> <tbody> <tr> <td>Analog</td> <td>NZ2GF2B-60AD4, NZ2GF2B-60DA4</td> </tr> <tr> <td>I/O</td> <td>NZ2GF2B1-16D, NZ2GF2B1-16T, NZ2GF2B1-16TE</td> </tr> <tr> <td>Counter</td> <td>NZ2GFCF-D62PD2</td> </tr> </tbody> </table>	Category	Model name	Analog	NZ2GF2B-60AD4, NZ2GF2B-60DA4	I/O	NZ2GF2B1-16D, NZ2GF2B1-16T, NZ2GF2B1-16TE	Counter	NZ2GFCF-D62PD2
	Category	Model name								
	Analog	NZ2GF2B-60AD4, NZ2GF2B-60DA4								
I/O	NZ2GF2B1-16D, NZ2GF2B1-16T, NZ2GF2B1-16TE									
Counter	NZ2GFCF-D62PD2									
CC-Link IE Field Network module	CC-Link IE Field Network master/local module *1 *1 The first five digits of the serial number are "14102" or later.									
CPU module	<table border="1" style="width: 100%; border-collapse: collapse;"> <thead> <tr> <th style="width: 30%;">Series</th> <th>Model</th> </tr> </thead> <tbody> <tr> <td>MELSEC-Q Series *1</td> <td>Universal model *2</td> </tr> <tr> <td>MELSEC-L Series</td> <td>LCPU *3</td> </tr> </tbody> </table> <p>*1 Not applicable to QCPU (A mode)</p> <p>*2 The first five digits of the serial number are "12012" or later.</p> <p>*3 The first five digits of the serial number are "13012" or later.</p>	Series	Model	MELSEC-Q Series *1	Universal model *2	MELSEC-L Series	LCPU *3			
Series	Model									
MELSEC-Q Series *1	Universal model *2									
MELSEC-L Series	LCPU *3									

Item	Description							
	Engineering software	GX Works2 *1 <table border="1"> <thead> <tr> <th>Language</th> <th>Software version</th> </tr> </thead> <tbody> <tr> <td>English version</td> <td>Version1.24A or later</td> </tr> <tr> <td>Chinese version</td> <td>Version1.49B or later</td> </tr> </tbody> </table> *1 For software versions applicable to the modules used, refer to "Relevant manuals".	Language	Software version	English version	Version1.24A or later	Chinese version	Version1.49B or later
Language	Software version							
English version	Version1.24A or later							
Chinese version	Version1.49B or later							
Programming language	Ladder							
Number of steps	274 steps (for MELSEC-Q series universal model CPU) * The number of steps of the FB in a program depends on the CPU model that is used and input and output definition.							
Function description	<p>1) By turning ON FB_EN (Execution command), the word data of the points set in i_WritePoint (Writing points) starting from the device specified in i_WriteData (Write data) is written to the remote buffer memory.</p> <p>(For example, when the remote buffer address is set to 1000H, the writing points are set to 10 in the input label, the write data is set to D100 in the output label, the values in D100 to D109 are written to the remote buffer memory.)</p> <div style="text-align: center;"> <p>The diagram illustrates the data transfer process. On the left, a vertical stack of boxes represents 'Write data' with addresses D100, D101, vertical ellipsis, and D109. A bracket on the left side of this stack is labeled 'Writing points (10 words)'. On the right, another vertical stack of boxes represents 'Remote buffer memory' with addresses 1000H, 1001H, vertical ellipsis, and 1009H. Arrows labeled 'Write' point from each data box to its corresponding memory address box.</p> </div> <p>2) When the CC-Link IE Field Network error occurs, the FB_ERROR output turns ON and processing is interrupted, and the error code is stored in ERROR_ID (Error code). Refer to the error code explanation section for details.</p>							
Compiling method	Macro type							

Item	Description
Restrictions and precautions	<ol style="list-style-type: none"> 1) The FB does not include error recovery processing. Program the error recovery processing separately in accordance with the required system operation. 2) The FB cannot be used in an interrupt program. 3) This FB uses the REMTO instruction. When operating this FB together with other FBs or using the REMFR or REMTO instruction in the ladder program, make sure that the channels used by the own station are not duplicated. 4) This FB uses index registers Z7 to Z9. Please do not use these index registers in an interrupt program. 5) This FB uses the transient transmission. An interlock program for the transient transmission is required. For the interlock program, refer to "1.4.1 Transient Transmission Interlock Program". 6) Every input must be provided with a value for proper FB operation.
FB operation type	Pulsed execution (multiple scan execution type)
Application example	Refer to "Appendix 1. FB Library Application Examples".
Timing chart	<div style="display: flex; justify-content: space-around;"> <div style="width: 45%;"> <p>[When operation completes without error]</p> </div> <div style="width: 45%;"> <p>[When an error occurs]</p> </div> </div>
Relevant manuals	<p>CC-Link IE Field Network Analog-Digital Converter Module User's Manual</p> <p>CC-Link IE Field Network Digital-Analog Converter Module User's Manual</p> <p>CC-Link IE Field Network Remote I/O Module User's Manual</p> <p>CC-Link IE Field Network High-Speed Counter Module User's Manual</p> <p>MELSEC-Q CC-Link IE Field Network Master/Local Module User's Manual</p> <p>MELSEC-L CC-Link IE Field Network Master/Local Module User's Manual</p> <p>QCPU User's Manual (Hardware Design, Maintenance and Inspection)</p> <p>MELSEC-L CPU Module User's Manual (Hardware Design, Maintenance and Inspection)</p> <p>GX Works2 Version 1 Operating Manual (Common)</p> <p>GX Works2 Version 1 Operating Manual (Simple Project, Function Block)</p>

Error codes

●Error code list

Error code	Description	Action
60 (Decimal)	The specified station number is not valid. The station number is not within the range of 1 to 120.	Please try again after confirming the setting.
D000 to DAF9 (Hexadecimal)	A CC-Link IE Field Network error has occurred.	For details, refer to the error code list of MELSEC-Q/MELSEC-L CC-Link IE Field Network Master/Local Module User's Manual.

Labels

●Input labels

Name (Comment)	Label name	Data type	Setting range	Description
Execution command	FB_EN	Bit	ON, OFF	ON: The FB is activated. OFF: The FB is not activated.
Module start XY address	i_Start_IO_No	Word	Depends on the I/O point range of the CPU. For details, refer to the CPU user's manual.	Specify the starting XY address (in hexadecimal) where the CC-Link IE Field Network master/local module is mounted or connected. (For example, enter H10 for X10.)
Station No.	i_Station_No	Word	1 to 120	Specify the station number of the target station.
Own station channel	i_CH_No	Word	1 to 32	Specify the channel for accessing other stations from the own station.
Remote buffer address	i_Address	Word	Depends on the remote buffer memory of the target module. For details, refer to the user's manual of the target module.	Specify the starting address (in hexadecimal) of the remote buffer memory to which the values are written.
Writing points	i_WritePoint	Word	1 to 240	Specify the writing points.
Write data	i_WriteData	Word	-	Specify the start device of devices that have the values to be written.

●Output labels

Name (Comment)	Label name	Data type	Initial value	Description
Execution status	FB_ENO	Bit	OFF	ON: Execution command is ON. OFF: Execution command is OFF.
Completed without error	FB_OK	Bit	OFF	When ON, it indicates that writing the value to the specified remote buffer memory is completed.
Error flag	FB_ERROR	Bit	OFF	When ON, it indicates that an error has occurred.
Error code	ERROR_ID	Word	0	FB error code output.

FB Version Upgrade History

Version	Date	Description
1.00A	2013/07/15	First edition

Note

This chapter includes information related to the function block.

It does not include information on restrictions of use such as combination with modules or programmable controller CPUs.

Please make sure to read user's manuals for the corresponding products before using the products.

2.3. M+NZ2GF_ReadExtModuleCode (Read extension module identification code)

FB Name

M+NZ2GF_ReadExtModuleCode

Function Overview

Item	Description																									
Function overview	Reads the identification code of a specified extension module.																									
Symbol	<div style="border: 1px solid black; padding: 10px; margin: 10px auto; width: fit-content;"> <p style="text-align: center; margin: 0;">M+NZ2GF_ReadExtModuleCode</p> <table style="width: 100%; border-collapse: collapse;"> <tr> <td style="width: 30%; padding: 2px;">Execution command</td> <td style="width: 30%; padding: 2px;">B : FB_EN</td> <td style="width: 30%; padding: 2px;">FB_ENO : B</td> <td style="width: 10%; padding: 2px;">Execution status</td> </tr> <tr> <td style="padding: 2px;">Module start XY address</td> <td style="padding: 2px;">W : i_Start_IO_No</td> <td style="padding: 2px;">FB_OK : B</td> <td style="padding: 2px;">Completed without error</td> </tr> <tr> <td style="padding: 2px;">Station No.</td> <td style="padding: 2px;">W : i_Station_No</td> <td style="padding: 2px;">o_Point : W</td> <td style="padding: 2px;">Points</td> </tr> <tr> <td style="padding: 2px;">Own station channel</td> <td style="padding: 2px;">W : i_CH_No</td> <td style="padding: 2px;">o_UnitType : W</td> <td style="padding: 2px;">Module type</td> </tr> <tr> <td style="padding: 2px;">Extension module No.</td> <td style="padding: 2px;">W : i_ExtensionNo</td> <td style="padding: 2px;">FB_ERROR : B</td> <td style="padding: 2px;">Error flag</td> </tr> <tr> <td></td> <td></td> <td style="padding: 2px;">ERROR_ID : W</td> <td style="padding: 2px;">Error code</td> </tr> </table> </div>		Execution command	B : FB_EN	FB_ENO : B	Execution status	Module start XY address	W : i_Start_IO_No	FB_OK : B	Completed without error	Station No.	W : i_Station_No	o_Point : W	Points	Own station channel	W : i_CH_No	o_UnitType : W	Module type	Extension module No.	W : i_ExtensionNo	FB_ERROR : B	Error flag			ERROR_ID : W	Error code
Execution command	B : FB_EN	FB_ENO : B	Execution status																							
Module start XY address	W : i_Start_IO_No	FB_OK : B	Completed without error																							
Station No.	W : i_Station_No	o_Point : W	Points																							
Own station channel	W : i_CH_No	o_UnitType : W	Module type																							
Extension module No.	W : i_ExtensionNo	FB_ERROR : B	Error flag																							
		ERROR_ID : W	Error code																							
Applicable hardware and software	CC-Link IE Field Network remote module	<table border="1" style="width: 100%; border-collapse: collapse;"> <thead> <tr> <th style="width: 30%;">Category</th> <th>Model</th> </tr> </thead> <tbody> <tr> <td>Analog</td> <td>NZ2GF2B-60AD4, NZ2GF2B-60DA4</td> </tr> <tr> <td>I/O</td> <td>NZ2GF2B1-16D, NZ2GF2B1-16T, NZ2GF2B1-16TE</td> </tr> <tr> <td>Counter</td> <td>NZ2GF2CF-D62PD2</td> </tr> </tbody> </table>	Category	Model	Analog	NZ2GF2B-60AD4, NZ2GF2B-60DA4	I/O	NZ2GF2B1-16D, NZ2GF2B1-16T, NZ2GF2B1-16TE	Counter	NZ2GF2CF-D62PD2																
	Category	Model																								
	Analog	NZ2GF2B-60AD4, NZ2GF2B-60DA4																								
I/O	NZ2GF2B1-16D, NZ2GF2B1-16T, NZ2GF2B1-16TE																									
Counter	NZ2GF2CF-D62PD2																									
CC-Link IE Field Network module	CC-Link IE Field Network master/local module *1 *1 The first five digits of the serial number are "14102" or later.																									
CPU module	<table border="1" style="width: 100%; border-collapse: collapse;"> <thead> <tr> <th style="width: 30%;">Series</th> <th>Model</th> </tr> </thead> <tbody> <tr> <td>MELSEC-Q Series *1</td> <td>Universal model *2</td> </tr> <tr> <td>MELSEC-L Series</td> <td>LCPU *3</td> </tr> </tbody> </table> <p>*1 Not applicable to QCPU (A mode) *2 The first five digits of the serial number are "12012" or later. *3 The first five digits of the serial number are "13012" or later.</p>	Series	Model	MELSEC-Q Series *1	Universal model *2	MELSEC-L Series	LCPU *3																			
Series	Model																									
MELSEC-Q Series *1	Universal model *2																									
MELSEC-L Series	LCPU *3																									

Item	Description							
	Engineering software	GX Works2 *1 <table border="1" data-bbox="692 248 1497 398"> <thead> <tr> <th>Language</th> <th>Software version</th> </tr> </thead> <tbody> <tr> <td>English version</td> <td>Version1.24A or later</td> </tr> <tr> <td>Chinese version</td> <td>Version1.49B or later</td> </tr> </tbody> </table> <p>*1 For software versions applicable to the modules used, refer to "Relevant manuals".</p>	Language	Software version	English version	Version1.24A or later	Chinese version	Version1.49B or later
Language	Software version							
English version	Version1.24A or later							
Chinese version	Version1.49B or later							
Programming language	Ladder							
Number of steps	307 steps (for MELSEC-Q series universal model CPU) * The number of steps of the FB in a program depends on the CPU model that is used and input and output definition.							
Function description	<ol style="list-style-type: none"> 1) By turning ON FB_EN (Execution command), the identification code of the specified extension module is read. The identification code is divided into the points and the module type, and then output. 2) When the setting value of the extension module number is out of range, the FB_ERROR output turns ON and processing is interrupted, and the error code is stored in ERROR_ID (Error code). Refer to the error code explanation section for details. 3) FB operation is one-shot only, triggered by the FB_EN signal. 4) When the CC-Link IE Field Network error occurs, the FB_ERROR output turns ON and processing is interrupted, and the error code is stored in ERROR_ID (Error code). Refer to the error code explanation section for details. 							
Compiling method	Macro type							
Restrictions and precautions	<ol style="list-style-type: none"> 1) The FB does not include error recovery processing. Program the error recovery processing separately in accordance with the required system operation. 2) The FB cannot be used in an interrupt program. 3) This FB uses the REMFR instruction. When operating this FB together with other FBs or using the REMFR or REMTO instruction in the ladder program, make sure that the channels used by the own station are not duplicated. 4) This FB uses index registers Z7 to Z9. Please do not use these index registers in an interrupt program. 5) This FB uses the transient transmission. An interlock program for the transient transmission is required. For the interlock program, refer to "1.4.1 Transient Transmission Interlock Program". 6) Every input must be provided with a value for proper FB operation. 							
FB operation type	Pulsed execution (multiple scan execution type)							
Application example	Refer to "Appendix 1. FB Library Application Examples".							

Item	Description
Timing chart	<div style="display: flex; justify-content: space-between;"> <div style="width: 48%;"> <p>[When operation completes without error]</p> </div> <div style="width: 48%;"> <p>[When an error occurs]</p> </div> </div>
Relevant manuals	<p>CC-Link IE Field Network Analog-Digital Converter Module User's Manual</p> <p>CC-Link IE Field Network Digital-Analog Converter Module User's Manual</p> <p>CC-Link IE Field Network Remote I/O Module User's Manual</p> <p>CC-Link IE Field Network High-Speed Counter Module User's Manual</p> <p>MELSEC-Q CC-Link IE Field Network Master/Local Module User's Manual</p> <p>MELSEC-L CC-Link IE Field Network Master/Local Module User's Manual</p> <p>QCPU User's Manual (Hardware Design, Maintenance and Inspection)</p> <p>MELSEC-L CPU Module User's Manual (Hardware Design, Maintenance and Inspection)</p> <p>GX Works2 Version 1 Operating Manual (Common)</p> <p>GX Works2 Version 1 Operating Manual (Simple Project, Function Block)</p>

Error codes

●Error code list

Error code	Description	Action
10 (Decimal)	The specified extension module number is not valid. Other than 1 is set as the extension module number.	Please try again after confirming the setting.
60 (Decimal)	The specified station number is not valid. The station number is not within the range of 1 to 120.	Please try again after confirming the setting.
D000 to DAF9 (Hexadecimal)	A CC-Link IE Field Network error has occurred.	For details, refer to the error code list of MELSEC-Q/MELSEC-L CC-Link IE Field Network Master/Local Module User's Manual.

Labels

●Input labels

Name (Comment)	Label name	Data type	Setting range	Description
Execution command	FB_EN	Bit	ON, OFF	ON: The FB is activated. OFF: The FB is not activated.
Module start XY address	i_Start_IO_No	Word	Depends on the I/O point range of the CPU. For details, refer to the CPU user's manual.	Specify the starting XY address (in hexadecimal) where the CC-Link IE Field Network master/local module is mounted or connected. (For example, enter H10 for X10.)
Station No.	i_Station_No	Word	1 to 120	Specify the station number of the target station.
Own station channel	i_CH_No	Word	1 to 32	Specify the channel for accessing other stations from the own station.
Extension module No.	i_ExtensionNo	Word	1	Specify the target extension module.

●Output labels

Name (Comment)	Label name	Data type	Initial value	Description
Execution status	FB_ENO	Bit	OFF	ON: Execution command is ON. OFF: Execution command is OFF.
Completed without error	FB_OK	Bit	OFF	When ON, it indicates that the reading the identification code of the extension module is completed.
Points	o_Point	Word	0	The points of the specified extension module are stored. 00H: 8 points 01H: 16 points 02H: 32 points 03H: 64 points
Module type	o_UnitType	Word	0	The module type of the specified extension module is stored. 00H: Unconnected 01H: Digital input module 02H: Digital output module
Error flag	FB_ERROR	Bit	OFF	When ON, it indicates that an error has occurred.

Name (Comment)	Label name	Data type	Initial value	Description
Error code	ERROR_ID	Word	0	FB error code output.

FB Version Upgrade History

Version	Date	Description
1.00A	2013/07/15	First edition

Note

This chapter includes information related to the function block.

It does not include information on restrictions of use such as combination with modules or programmable controller CPUs.

Please make sure to read user's manuals for the corresponding products before using the products.

2.4. M+NZ2GF_ReadOutputOnTimes (Read number of ON times integration value)

FB Name

M+NZ2GF_ReadOutputOnTimes

Function Overview

Item	Description																			
Function overview	Reads the number of ON times integration values Y0 to YF of a specified extension module.																			
Symbol	<table border="1" style="width: 100%; border-collapse: collapse;"> <thead> <tr> <th colspan="3" style="text-align: center;">M+NZ2GF_ReadOutputOnTimes</th> </tr> </thead> <tbody> <tr> <td style="width: 30%;">Execution command</td> <td style="width: 30%;">B : FB_EN</td> <td style="width: 40%;">FB_ENO : B — Execution status</td> </tr> <tr> <td>Module start XY address</td> <td>W : i_Start_IO_No</td> <td>FB_OK : B — Completed without error</td> </tr> <tr> <td>Station No.</td> <td>W : i_Station_No</td> <td>o_OutputONTotals : W — Number of ON times integration value</td> </tr> <tr> <td>Own station channel</td> <td>W : i_CH_No</td> <td>FB_ERROR : B — Error flag</td> </tr> <tr> <td>Extension module No.</td> <td>W : i_ExtensionNo</td> <td>ERROR_ID : W — Error code</td> </tr> </tbody> </table>		M+NZ2GF_ReadOutputOnTimes			Execution command	B : FB_EN	FB_ENO : B — Execution status	Module start XY address	W : i_Start_IO_No	FB_OK : B — Completed without error	Station No.	W : i_Station_No	o_OutputONTotals : W — Number of ON times integration value	Own station channel	W : i_CH_No	FB_ERROR : B — Error flag	Extension module No.	W : i_ExtensionNo	ERROR_ID : W — Error code
M+NZ2GF_ReadOutputOnTimes																				
Execution command	B : FB_EN	FB_ENO : B — Execution status																		
Module start XY address	W : i_Start_IO_No	FB_OK : B — Completed without error																		
Station No.	W : i_Station_No	o_OutputONTotals : W — Number of ON times integration value																		
Own station channel	W : i_CH_No	FB_ERROR : B — Error flag																		
Extension module No.	W : i_ExtensionNo	ERROR_ID : W — Error code																		
Applicable hardware and software	CC-Link IE Field Network remote module	<table border="1" style="width: 100%; border-collapse: collapse;"> <thead> <tr> <th style="width: 30%;">Category</th> <th>Model</th> </tr> </thead> <tbody> <tr> <td>Analog</td> <td>NZ2GF2B-60AD4, NZ2GF2B-60DA4</td> </tr> <tr> <td>I/O</td> <td>NZ2GF2B1-16D, NZ2GF2B1-16T, NZ2GF2B1-16TE</td> </tr> <tr> <td>Counter</td> <td>NZ2GFCF-D62PD2</td> </tr> </tbody> </table>	Category	Model	Analog	NZ2GF2B-60AD4, NZ2GF2B-60DA4	I/O	NZ2GF2B1-16D, NZ2GF2B1-16T, NZ2GF2B1-16TE	Counter	NZ2GFCF-D62PD2										
	Category	Model																		
	Analog	NZ2GF2B-60AD4, NZ2GF2B-60DA4																		
I/O	NZ2GF2B1-16D, NZ2GF2B1-16T, NZ2GF2B1-16TE																			
Counter	NZ2GFCF-D62PD2																			
CC-Link IE Field Network module	CC-Link IE Field Network master/local module *1 *1 The first five digits of the serial number are "14102" or later.																			
CPU module	<table border="1" style="width: 100%; border-collapse: collapse;"> <thead> <tr> <th style="width: 30%;">Series</th> <th>Model</th> </tr> </thead> <tbody> <tr> <td>MELSEC-Q Series *1</td> <td>Universal model *2</td> </tr> <tr> <td>MELSEC-L Series</td> <td>LCPU *3</td> </tr> </tbody> </table> <p>*1 Not applicable to QCPU (A mode) *2 The first five digits of the serial number are "12012" or later. *3 The first five digits of the serial number are "13012" or later.</p>	Series	Model	MELSEC-Q Series *1	Universal model *2	MELSEC-L Series	LCPU *3													
Series	Model																			
MELSEC-Q Series *1	Universal model *2																			
MELSEC-L Series	LCPU *3																			

Item	Description							
	Engineering software	GX Works2 *1 <table border="1" style="margin-left: 20px;"> <thead> <tr> <th>Language</th> <th>Software version</th> </tr> </thead> <tbody> <tr> <td>English version</td> <td>Version1.24A or later</td> </tr> <tr> <td>Chinese version</td> <td>Version1.49B or later</td> </tr> </tbody> </table> <p>*1 For software versions applicable to the modules used, refer to "Relevant manuals".</p>	Language	Software version	English version	Version1.24A or later	Chinese version	Version1.49B or later
Language	Software version							
English version	Version1.24A or later							
Chinese version	Version1.49B or later							
Programming language	Ladder							
Number of steps	305 steps (for MELSEC-Q series universal model CPU) * The number of steps of the FB in a program depends on the CPU model that is used and input and output definition.							
Function description	<p>1) By turning ON FB_EN (Execution command), the number of ON times integration values Y0 to YF of the specified extension module is read. The read number of ON times integration values Y0 to YF are stored in devices starting from the device set in o_OutputONTotal (Number of ON times integration value). The stored data is equivalent to 32 words. (For example, when the number of ON times integration value in the output label is set to D100, the number of ON times integration values Y0 to YF are stored in D100 to D131. The number of ON times integration value Y0 is stored in D100 and D101.)</p> <div style="text-align: center;"> <pre> graph LR subgraph Remote_buffer_memory [Remote buffer memory] R730[730H] R731[731H] Rdots[...] R74F[74FH] end subgraph Read_data [Read data] D100[D100] D101[D101] Ddots[...] D131[D131] end R730 -- Read --> D100 R731 -- Read --> D101 Rdots -- Read --> Ddots R74F -- Read --> D131 </pre> </div> <p>2) When FB_EN (Execution command) is turned OFF during the number of ON times integration value reading processing, the values read previously remain.</p> <p>3) When the setting value of the extension module number is out of range, the FB_ERROR output turns ON and processing is interrupted, and the error code is stored in ERROR_ID (Error code). Refer to the error code explanation section for details.</p> <p>4) When the CC-Link IE Field Network error occurs, the FB_ERROR output turns ON and processing is interrupted, and the error code is stored in ERROR_ID (Error code). Refer to the error code explanation section for details.</p>							
Compiling method	Macro type							

Item	Description
Restrictions and precautions	<ol style="list-style-type: none"> 1) The FB does not include error recovery processing. Program the error recovery processing separately in accordance with the required system operation. 2) The FB cannot be used in an interrupt program. 3) This FB uses the REMFR instruction. When operating this FB together with other FBs or using the REMFR or REMTO instruction in the ladder program, make sure that the channels used by the own station are not duplicated. 4) This FB requires multiple scans from ON of FB_EN (Execution command) to ON of FB_OK (Completed without error). 5) This FB uses index registers Z7 to Z9. Please do not use these index registers in an interrupt program. 6) This FB uses the transient transmission. An interlock program for the transient transmission is required. For the interlock program, refer to "1.4.1 Transient Transmission Interlock Program". 7) Every input must be provided with a value for proper FB operation.
FB operation type	Real-time execution
Application example	Refer to "Appendix 1. FB Library Application Examples".
Timing chart	<div style="display: flex; justify-content: space-between;"> <div style="width: 48%;"> <p>[When operation completes without error]</p> </div> <div style="width: 48%;"> <p>[When an error occurs]</p> </div> </div> <p>*1.Turns ON only for one scan.</p> <p>*2.The read data is updated every time the reading processing is completed.</p>

Item	Description
Relevant manuals	CC-Link IE Field Network Analog-Digital Converter Module User's Manual CC-Link IE Field Network Digital-Analog Converter Module User's Manual CC-Link IE Field Network Remote I/O Module User's Manual CC-Link IE Field Network High-Speed Counter Module User's Manual MELSEC-Q CC-Link IE Field Network Master/Local Module User's Manual MELSEC-L CC-Link IE Field Network Master/Local Module User's Manual QCPU User's Manual (Hardware Design, Maintenance and Inspection) MELSEC-L CPU Module User's Manual (Hardware Design, Maintenance and Inspection) GX Works2 Version 1 Operating Manual (Common) GX Works2 Version 1 Operating Manual (Simple Project, Function Block)

Error codes

●Error code list

Error code	Description	Action
10 (Decimal)	The specified extension module number is not valid. Other than 1 is set as the extension module number.	Please try again after confirming the setting.
60 (Decimal)	The specified station number is not valid. The station number is not within the range of 1 to 120.	Please try again after confirming the setting.
D000 to DAF9 (Hexadecimal)	A CC-Link IE Field Network error has occurred.	For details, refer to the error code list of MELSEC-Q/MELSEC-L CC-Link IE Field Network Master/Local Module User's Manual.

Labels

●Input labels

Name (Comment)	Label name	Data type	Setting range	Description
Execution command	FB_EN	Bit	ON, OFF	ON: The FB is activated. OFF: The FB is not activated.
Module start XY address	i_Start_IO_No	Word	Depends on the I/O point range of the CPU. For details, refer to the CPU user's manual.	Specify the starting XY address (in hexadecimal) where the CC-Link IE Field Network master/local module is mounted or connected. (For example, enter H10 for X10.)
Station No.	i_Station_No	Word	1 to 120	Specify the station number of the target station.
Own station channel	i_CH_No	Word	1 to 32	Specify the channel for accessing other stations from the own station.
Extension module No.	i_ExtensionNo	Word	1	Specify the target extension module.

●Output labels

Name (Comment)	Label name	Data type	Initial value	Description
Execution status	FB_ENO	Bit	OFF	ON: During FB execution OFF: During FB stopped
Completed without error	FB_OK	Bit	OFF	When ON, it indicates that reading the identification code of the extension module is completed.
Number of ON times integration value	o_OutputONTotals	Word	0	Specify the device in which the number of ON times integration values Y0 to YF are stored.
Error flag	FB_ERROR	Bit	OFF	When ON, it indicates that an error has occurred.
Error code	ERROR_ID	Word	0	FB error code output.

FB Version Upgrade History

Version	Date	Description
1.00A	2013/07/15	First edition

Note

This chapter includes information related to the function block.

It does not include information on restrictions of use such as combination with modules or programmable controller CPUs.

Please make sure to read user's manuals for the corresponding products before using the products.

2.5. M+NZ2GF_OutputOnTimesTotalClr (Number of ON times integration value clear)

FB Name

M+NZ2GF_OutputOnTimesTotalClr

Function Overview

Item	Description									
Function overview	Clears the number of ON times integration values Y0 to YF of a specified extension module.									
Symbol	<div style="display: flex; align-items: center; justify-content: space-between;"> <div style="width: 45%;"> <p>Execution command — B : FB_EN</p> <p>Module start XY address — W : i_Start_IO_No</p> <p>Station No. — W : i_Station_No</p> <p>Own station channel — W : i_CH_No</p> <p>Extension module No. — W : i_ExtensionNo</p> <p>Number of ON times integration value clear selection — W : i_OutputClrSct</p> </div> <div style="width: 10%; text-align: center; border: 1px solid black; padding: 5px;"> <p>M+NZ2GF_OutputOnTimesTotalClr</p> </div> <div style="width: 45%;"> <p>FB_ENO : B — Execution status</p> <p>FB_OK : B — Completed without error</p> <p>FB_ERROR : B — Error flag</p> <p>ERROR_ID : W — Error code</p> </div> </div>									
Applicable hardware and software	CC-Link IE Field Network remote module	<table border="1" style="width: 100%; border-collapse: collapse;"> <thead> <tr> <th style="width: 30%;">Category</th> <th>Model</th> </tr> </thead> <tbody> <tr> <td>Analog</td> <td>NZ2GF2B-60AD4, NZ2GF2B-60DA4</td> </tr> <tr> <td>I/O</td> <td>NZ2GF2B1-16D, NZ2GF2B1-16T, NZ2GF2B1-16TE</td> </tr> <tr> <td>Counter</td> <td>NZ2GF2B1-16TE</td> </tr> </tbody> </table>	Category	Model	Analog	NZ2GF2B-60AD4, NZ2GF2B-60DA4	I/O	NZ2GF2B1-16D, NZ2GF2B1-16T, NZ2GF2B1-16TE	Counter	NZ2GF2B1-16TE
	Category	Model								
	Analog	NZ2GF2B-60AD4, NZ2GF2B-60DA4								
I/O	NZ2GF2B1-16D, NZ2GF2B1-16T, NZ2GF2B1-16TE									
Counter	NZ2GF2B1-16TE									
CC-Link IE Field Network module	CC-Link IE Field Network master/local module *1 *1 The first five digits of the serial number are "14102" or later.									
CPU module	<table border="1" style="width: 100%; border-collapse: collapse;"> <thead> <tr> <th style="width: 30%;">Series</th> <th>Model</th> </tr> </thead> <tbody> <tr> <td>MELSEC-Q Series *1</td> <td>Universal model *2</td> </tr> <tr> <td>MELSEC-L Series</td> <td>LCPU *3</td> </tr> </tbody> </table> <p>*1 Not applicable to QCPU (A mode)</p> <p>*2 The first five digits of the serial number are "12012" or later.</p> <p>*3 The first five digits of the serial number are "13012" or later.</p>	Series	Model	MELSEC-Q Series *1	Universal model *2	MELSEC-L Series	LCPU *3			
Series	Model									
MELSEC-Q Series *1	Universal model *2									
MELSEC-L Series	LCPU *3									

Item	Description							
	Engineering software	GX Works2 *1 <table border="1"> <thead> <tr> <th>Language</th> <th>Software version</th> </tr> </thead> <tbody> <tr> <td>English version</td> <td>Version1.24A or later</td> </tr> <tr> <td>Chinese version</td> <td>Version1.49B or later</td> </tr> </tbody> </table> *1 For software versions applicable to the modules used, refer to "Relevant manuals".	Language	Software version	English version	Version1.24A or later	Chinese version	Version1.49B or later
Language	Software version							
English version	Version1.24A or later							
Chinese version	Version1.49B or later							
Programming language	Ladder							
Number of steps	397 steps (for MELSEC-Q series universal model CPU) * The number of steps of the FB in a program depends on the CPU model that is used and input and output definition.							
Function description	<ol style="list-style-type: none"> 1) By turning ON FB_EN (Execution command), the number of ON times integration value selected in i_OutputClrSlct (Number of ON times integration value clear selection) is cleared. 2) FB operation is one-shot only, triggered by the FB_EN signal. 3) When the setting value of the extension module number is out of range, the FB_ERROR output turns ON and processing is interrupted, and the error code is stored in ERROR_ID. Refer to the error code explanation section for details. 4) When the CC-Link IE Field Network error occurs, the FB_ERROR output turns ON and processing is interrupted, and the error code is stored in ERROR_ID (Error code). Refer to the error code explanation section for details. 							
Compiling method	Macro type							
Restrictions and precautions	<ol style="list-style-type: none"> 1) The FB does not include error recovery processing. Program the error recovery processing separately in accordance with the required system operation. 2) The FB cannot be used in an interrupt program. 3) This FB uses the REMFR and REMTO instructions. When operating this FB together with other FBs or using the REMFR or REMTO instruction in the ladder program, make sure that the channels used by the own station are not duplicated. 4) This FB uses index registers Z7 to Z9. Please do not use these index registers in an interrupt program. 5) This FB uses the transient transmission. An interlock program for the transient transmission is required. For the interlock program, refer to "1.4.1 Transient Transmission Interlock Program". 6) Every input must be provided with a value for proper FB operation. 							
FB operation type	Pulsed execution (multiple scan execution type)							
Application example	Refer to "Appendix 1. FB Library Application Examples".							

Item	Description
Timing chart	<div style="display: flex; justify-content: space-between;"> <div style="width: 48%;"> <p>[When operation completes without error]</p> </div> <div style="width: 48%;"> <p>[When an error occurs]</p> </div> </div>
Relevant manuals	<p>CC-Link IE Field Network Analog-Digital Converter Module User's Manual</p> <p>CC-Link IE Field Network Digital-Analog Converter Module User's Manual</p> <p>CC-Link IE Field Network Remote I/O Module User's Manual</p> <p>CC-Link IE Field Network High-Speed Counter Module User's Manual</p> <p>MELSEC-Q CC-Link IE Field Network Master/Local Module User's Manual</p> <p>MELSEC-L CC-Link IE Field Network Master/Local Module User's Manual</p> <p>QCPU User's Manual (Hardware Design, Maintenance and Inspection)</p> <p>MELSEC-L CPU Module User's Manual (Hardware Design, Maintenance and Inspection)</p> <p>GX Works2 Version 1 Operating Manual (Common)</p> <p>GX Works2 Version 1 Operating Manual (Simple Project, Function Block)</p>

Error codes

●Error code list

Error code	Description	Action
10 (Decimal)	The specified extension module number is not valid. Other than 1 is set as the extension module number.	Please try again after confirming the setting.
60 (Decimal)	The specified station number is not valid. The station number is not within the range of 1 to 120.	Please try again after confirming the setting.
D000 to DAF9 (Hexadecimal)	A CC-Link IE Field Network error has occurred.	For details, refer to the error code list of MELSEC-Q/MELSEC-L CC-Link IE Field Network Master/Local Module User's Manual.

Labels

● Input labels

Name (Comment)	Label name	Data type	Setting range	Description
Execution command	FB_EN	Bit	ON, OFF	ON: The FB is activated. OFF: The FB is not activated.
Module start XY address	i_Start_IO_No	Word	Depends on the I/O point range of the CPU. For details, refer to the CPU user's manual.	Specify the starting XY address (in hexadecimal) where the CC-Link IE Field Network master/local module is mounted or connected. (For example, enter H10 for X10.)
Station No.	i_Station_No	Word	1 to 120	Specify the station number of the target station.
Own station channel	i_CH_No	Word	1 to 32	Specify the channel for accessing other stations from the own station.
Extension module No.	i_ExtensionNo	Word	1	Specify the target extension module.
Number of ON times integration value clear selection	i_OutputClrSlct	Word	b00: Y0 b01: Y1 b02: Y2 b03: Y3 b04: Y4 b05: Y5 b06: Y6 b07: Y7 b08: Y8 b09: Y9 b10: YA b11: YB b12: YC b13: YD b14: YE b15: YF	Select the range to clear the number of ON times integration value. (Example: To clear Y0, Y2, and Y5, set "0025H".)

●Output labels

Name (Comment)	Label name	Data type	Initial value	Description
Execution status	FB_ENO	Bit	OFF	ON: Execution command is ON. OFF: Execution command is OFF.
Completed without error	FB_OK	Bit	OFF	When ON, it indicates that clearing the number of ON times integration value is completed.
Error flag	FB_ERROR	Bit	OFF	When ON, it indicates that an error has occurred.
Error code	ERROR_ID	Word	0	FB error code output.

FB Version Upgrade History

Version	Date	Description
1.00A	2013/07/15	First edition

Note

This chapter includes information related to the function block.

It does not include information on restrictions of use such as combination with modules or programmable controller CPUs.

Please make sure to read user's manuals for the corresponding products before using the products.

2.6. M+NZ2GF_ParameterInfoClr (Parameter information initialization)

FB Name

M+NZ2GF_ParameterInfoClr

Function Overview

Item	Description									
Function overview	Initializes the parameter information.									
Symbol	<div style="display: flex; align-items: center; justify-content: space-between;"> <div style="width: 30%;"> <p>Execution command — B : FB_EN</p> <p>Module start XY address — W : i_Start_IO_No</p> <p>Station No. — W : i_Station_No</p> <p>Own station channel — W : i_CH_No</p> </div> <div style="width: 40%; border: 1px solid black; padding: 5px;"> <p style="text-align: center; margin: 0;">M+NZ2GF_ParameterInfoClr</p> <table style="width: 100%; border-collapse: collapse;"> <tr> <td style="width: 50%; border-right: 1px solid black; padding: 2px;">FB_ENO : B</td> <td style="padding: 2px;">— Execution status</td> </tr> <tr> <td style="border-right: 1px solid black; padding: 2px;">FB_OK : B</td> <td style="padding: 2px;">— Completed without error</td> </tr> <tr> <td style="border-right: 1px solid black; padding: 2px;">FB_ERROR : B</td> <td style="padding: 2px;">— Error flag</td> </tr> <tr> <td style="border-right: 1px solid black; padding: 2px;">ERROR_ID : W</td> <td style="padding: 2px;">— Error code</td> </tr> </table> </div> <div style="width: 25%; padding-left: 10px;"> <p>— Execution status</p> <p>— Completed without error</p> <p>— Error flag</p> <p>— Error code</p> </div> </div>		FB_ENO : B	— Execution status	FB_OK : B	— Completed without error	FB_ERROR : B	— Error flag	ERROR_ID : W	— Error code
FB_ENO : B	— Execution status									
FB_OK : B	— Completed without error									
FB_ERROR : B	— Error flag									
ERROR_ID : W	— Error code									
Applicable hardware and software	CC-Link IE Field Network remote module	<table border="1" style="width: 100%; border-collapse: collapse;"> <thead> <tr> <th style="width: 30%;">Category</th> <th>Model</th> </tr> </thead> <tbody> <tr> <td>Analog</td> <td>NZ2GF2B-60AD4, NZ2GF2B-60DA4</td> </tr> <tr> <td>I/O</td> <td>NZ2GF2B1-16D, NZ2GF2B1-16T, NZ2GF2B1-16TE</td> </tr> <tr> <td>Counter</td> <td>NZ2GF2CF-D62PD2</td> </tr> </tbody> </table>	Category	Model	Analog	NZ2GF2B-60AD4, NZ2GF2B-60DA4	I/O	NZ2GF2B1-16D, NZ2GF2B1-16T, NZ2GF2B1-16TE	Counter	NZ2GF2CF-D62PD2
	Category	Model								
	Analog	NZ2GF2B-60AD4, NZ2GF2B-60DA4								
	I/O	NZ2GF2B1-16D, NZ2GF2B1-16T, NZ2GF2B1-16TE								
Counter	NZ2GF2CF-D62PD2									
CC-Link IE Field Network module	CC-Link IE Field Network master/local module *1 *1 The first five digits of the serial number are "14102" or later.									
CPU module	<table border="1" style="width: 100%; border-collapse: collapse;"> <thead> <tr> <th style="width: 30%;">Series</th> <th>Model</th> </tr> </thead> <tbody> <tr> <td>MELSEC-Q Series *1</td> <td>Universal model *2</td> </tr> <tr> <td>MELSEC-L Series</td> <td>LCPU *3</td> </tr> </tbody> </table> <p>*1 Not applicable to QCPU (A mode)</p> <p>*2 The first five digits of the serial number are "12012" or later.</p> <p>*3 The first five digits of the serial number are "13012" or later.</p>	Series	Model	MELSEC-Q Series *1	Universal model *2	MELSEC-L Series	LCPU *3			
Series	Model									
MELSEC-Q Series *1	Universal model *2									
MELSEC-L Series	LCPU *3									
Engineering software	<p>GX Works2 *1</p> <table border="1" style="width: 100%; border-collapse: collapse;"> <thead> <tr> <th style="width: 30%;">Language</th> <th>Software version</th> </tr> </thead> <tbody> <tr> <td>English version</td> <td>Version1.24A or later</td> </tr> <tr> <td>Chinese version</td> <td>Version1.49B or later</td> </tr> </tbody> </table> <p>*1 For software versions applicable to the modules used, refer to "Relevant manuals".</p>	Language	Software version	English version	Version1.24A or later	Chinese version	Version1.49B or later			
Language	Software version									
English version	Version1.24A or later									
Chinese version	Version1.49B or later									

Item	Description
Programming language	Ladder
Number of steps	377 steps (for MELSEC-Q series universal model CPU) * The number of steps of the FB in a program depends on the CPU model that is used and input and output definition.
Function description	<ol style="list-style-type: none"> 1) By turning ON FB_EN (Execution command), the parameter information is initialized. 2) FB operation is one-shot only, triggered by the FB_EN signal. 3) When the CC-Link IE Field Network error occurs, the FB_ERROR output turns ON and processing is interrupted, and the error code is stored in ERROR_ID (Error code). Refer to the error code explanation section for details.
Compiling method	Macro type
Restrictions and precautions	<ol style="list-style-type: none"> 1) The FB does not include error recovery processing. Program the error recovery processing separately in accordance with the required system operation. 2) The FB cannot be used in an interrupt program. 3) This FB uses the REMFR and REMTO instructions. When operating this FB together with other FBs or using the REMFR or REMTO instruction in the ladder program, make sure that the channels used by the own station are not duplicated. 4) This FB uses index registers Z7 to Z9. Please do not use these index registers in an interrupt program. 5) This FB uses the transient transmission. An interlock program for the transient transmission is required. For the interlock program, refer to "1.4.1 Transient Transmission Interlock Program". 6) Every input must be provided with a value for proper FB operation.
FB operation type	Pulsed execution (multiple scan execution type)
Application example	Refer to "Appendix 1. FB Library Application Examples".
Timing chart	<div style="display: flex; justify-content: space-around;"> <div style="width: 45%;"> <p>[When operation completes without error]</p> </div> <div style="width: 45%;"> <p>[When an error occurs]</p> </div> </div>

Item	Description
Relevant manuals	CC-Link IE Field Network Analog-Digital Converter Module User's Manual CC-Link IE Field Network Digital-Analog Converter Module User's Manual CC-Link IE Field Network Remote I/O Module User's Manual CC-Link IE Field Network High-Speed Counter Module User's Manual MELSEC-Q CC-Link IE Field Network Master/Local Module User's Manual MELSEC-L CC-Link IE Field Network Master/Local Module User's Manual QCPU User's Manual (Hardware Design, Maintenance and Inspection) MELSEC-L CPU Module User's Manual (Hardware Design, Maintenance and Inspection) GX Works2 Version 1 Operating Manual (Common) GX Works2 Version 1 Operating Manual (Simple Project, Function Block)

Error codes

●Error code list

Error code	Description	Action
60 (Decimal)	The specified station number is not valid. The station number is not within the range of 1 to 120.	Please try again after confirming the setting.
D000 to DAF9 (Hexadecimal)	A CC-Link IE Field Network error has occurred.	For details, refer to the error code list of MELSEC-Q/MELSEC-L CC-Link IE Field Network Master/Local Module User's Manual.

Labels

●Input labels

Name (Comment)	Label name	Data type	Setting range	Description
Execution command	FB_EN	Bit	ON, OFF	ON: The FB is activated. OFF: The FB is not activated.
Module start XY address	i_Start_IO_No	Word	Depends on the I/O point range of the CPU. For details, refer to the CPU user's manual.	Specify the starting XY address (in hexadecimal) where the CC-Link IE Field Network master/local module is mounted or connected. (For example, enter H10 for X10.)
Station No.	i_Station_No	Word	1 to 120	Specify the station number of the target station.
Own station channel	i_CH_No	Word	1 to 32	Specify the channel for accessing other stations from the own station.

●Output labels

Name (Comment)	Label name	Data type	Initial value	Description
Execution status	FB_ENO	Bit	OFF	ON: Execution command is ON. OFF: Execution command is OFF.
Completed without error	FB_OK	Bit	OFF	When ON, it indicates that initializing the parameter information is completed.
Error flag	FB_ERROR	Bit	OFF	When ON, it indicates that an error has occurred.
Error code	ERROR_ID	Word	0	FB error code output.

FB Version Upgrade History

Version	Date	Description
1.00A	2013/07/15	First edition

Note

This chapter includes information related to the function block.

It does not include information on restrictions of use such as combination with modules or programmable controller CPUs.

Please make sure to read user's manuals for the corresponding products before using the products.

2.7. M+NZ2GF_ErrorHistoryClr (Error history clear)

FB Name

M+NZ2GF_ErrorHistoryClr

Function Overview

Item	Description									
Function overview	Clears the error history.									
Symbol	<div style="display: flex; align-items: center; justify-content: space-between;"> <div style="width: 30%;"> <p>Execution command — B : FB_EN</p> <p>Module start XY address — W : i_Start_IO_No</p> <p>Station No. — W : i_Station_No</p> <p>Own station channel — W : i_CH_No</p> </div> <div style="width: 40%; border: 1px solid black; padding: 5px; text-align: center;"> <p>M+NZ2GF_ErrorHistoryClr</p> </div> <div style="width: 30%;"> <p>FB_ENO : B — Execution status</p> <p>FB_OK : B — Completed without error</p> <p>FB_ERROR : B — Error flag</p> <p>ERROR_ID : W — Error code</p> </div> </div>									
Applicable hardware and software	CC-Link IE Field Network remote module	<table border="1" style="width: 100%;"> <thead> <tr> <th>Category</th> <th>Model</th> </tr> </thead> <tbody> <tr> <td>Analog</td> <td>NZ2GF2B-60AD4, NZ2GF2B-60DA4</td> </tr> <tr> <td>I/O</td> <td>NZ2GF2B1-16D, NZ2GF2B1-16T, NZ2GF2B1-16TE</td> </tr> <tr> <td>Counter</td> <td>NZ2GFCF-D62PD2</td> </tr> </tbody> </table>	Category	Model	Analog	NZ2GF2B-60AD4, NZ2GF2B-60DA4	I/O	NZ2GF2B1-16D, NZ2GF2B1-16T, NZ2GF2B1-16TE	Counter	NZ2GFCF-D62PD2
	Category	Model								
	Analog	NZ2GF2B-60AD4, NZ2GF2B-60DA4								
	I/O	NZ2GF2B1-16D, NZ2GF2B1-16T, NZ2GF2B1-16TE								
Counter	NZ2GFCF-D62PD2									
CC-Link IE Field Network module	CC-Link IE Field Network master/local module *1 *1 The first five digits of the serial number are "14102" or later.									
CPU module	<table border="1" style="width: 100%;"> <thead> <tr> <th>Series</th> <th>Model</th> </tr> </thead> <tbody> <tr> <td>MELSEC-Q Series *1</td> <td>Universal model *2</td> </tr> <tr> <td>MELSEC-L Series</td> <td>LCPU *3</td> </tr> </tbody> </table> <p>*1 Not applicable to QCPU (A mode) *2 The first five digits of the serial number are "12012" or later. *3 The first five digits of the serial number are "13012" or later.</p>	Series	Model	MELSEC-Q Series *1	Universal model *2	MELSEC-L Series	LCPU *3			
Series	Model									
MELSEC-Q Series *1	Universal model *2									
MELSEC-L Series	LCPU *3									
Engineering software	<p>GX Works2 *1</p> <table border="1" style="width: 100%;"> <thead> <tr> <th>Language</th> <th>Software version</th> </tr> </thead> <tbody> <tr> <td>English version</td> <td>Version1.24A or later</td> </tr> <tr> <td>Chinese version</td> <td>Version1.49B or later</td> </tr> </tbody> </table> <p>*1 For software versions applicable to the modules used, refer to "Relevant manuals".</p>	Language	Software version	English version	Version1.24A or later	Chinese version	Version1.49B or later			
Language	Software version									
English version	Version1.24A or later									
Chinese version	Version1.49B or later									

Item	Description
Programming language	Ladder
Number of steps	368 steps (for MELSEC-Q series universal model CPU) * The number of steps of the FB in a program depends on the CPU model that is used and input and output definition.
Function description	<ol style="list-style-type: none"> 1) By turning ON FB_EN (Execution command), the error history is cleared. 2) FB operation is one-shot only, triggered by the FB_EN signal. 3) When the CC-Link IE Field Network error occurs, the FB_ERROR output turns ON and processing is interrupted, and the error code is stored in ERROR_ID (Error code). Refer to the error code explanation section for details.
Compiling method	Macro type
Restrictions and precautions	<ol style="list-style-type: none"> 1) The FB does not include error recovery processing. Program the error recovery processing separately in accordance with the required system operation. 2) The FB cannot be used in an interrupt program. 3) This FB uses the REMFR and REMTO instructions. When operating this FB together with other FBs or using the REMFR or REMTO instruction in the ladder program, make sure that the channels used by the own station are not duplicated. 4) This FB uses index registers Z7 to Z9. Please do not use these index registers in an interrupt program. 5) This FB uses the transient transmission. An interlock program for the transient transmission is required. For the interlock program, refer to "1.4.1 Transient Transmission Interlock Program". 6) Every input must be provided with a value for proper FB operation.
FB operation type	Pulsed execution (multiple scan execution type)
Application example	Refer to "Appendix 1. FB Library Application Examples".
Timing chart	<div style="display: flex; justify-content: space-around;"> <div style="width: 45%;"> <p>[When operation completes without error]</p> </div> <div style="width: 45%;"> <p>[When an error occurs]</p> </div> </div>

Item	Description
Relevant manuals	CC-Link IE Field Network Analog-Digital Converter Module User's Manual CC-Link IE Field Network Digital-Analog Converter Module User's Manual CC-Link IE Field Network Remote I/O Module User's Manual CC-Link IE Field Network High-Speed Counter Module User's Manual MELSEC-Q CC-Link IE Field Network Master/Local Module User's Manual MELSEC-L CC-Link IE Field Network Master/Local Module User's Manual QCPU User's Manual (Hardware Design, Maintenance and Inspection) MELSEC-L CPU Module User's Manual (Hardware Design, Maintenance and Inspection) GX Works2 Version 1 Operating Manual (Common) GX Works2 Version 1 Operating Manual (Simple Project, Function Block)

Error code

●Error code list

Error code	Description	Action
60 (Decimal)	The specified station number is not valid. The station number is not within the range of 1 to 120.	Please try again after confirming the setting.
D000 to DAF9 (Hexadecimal)	A CC-Link IE Field Network error has occurred.	For details, refer to the error code list of MELSEC-Q/MELSEC-L CC-Link IE Field Network Master/Local Module User's Manual.

Labels

●Input labels

Name (Comment)	Label name	Data type	Setting range	Description
Execution command	FB_EN	Bit	ON, OFF	ON: The FB is activated. OFF: The FB is not activated.
Module start XY address	i_Start_IO_No	Word	Depends on the I/O point range of the CPU. For details, refer to the CPU user's manual.	Specify the starting XY address (in hexadecimal) where the CC-Link IE Field Network master/local module is mounted or connected. (For example, enter H10 for X10.)
Station No.	i_Station_No	Word	1 to 120	Specify the station number of the target station.
Own station channel	i_CH_No	Word	1 to 32	Specify the channel for accessing other stations from the own station.

●Output labels

Name (Comment)	Label name	Data type	Initial value	Description
Execution status	FB_ENO	Bit	OFF	ON: Execution command is ON. OFF: Execution command is OFF.
Completed without error	FB_OK	Bit	OFF	When ON, it indicates that clearing the error history is completed.
Error flag	FB_ERROR	Bit	OFF	When ON, it indicates that an error has occurred.
Error code	ERROR_ID	Word	0	FB error code output.

FB Version Upgrade History

Version	Date	Description
1.00A	2013/07/15	First edition

Note

This chapter includes information related to the function block.

It does not include information on restrictions of use such as combination with modules or programmable controller CPUs.

Please make sure to read user's manuals for the corresponding products before using the products.

2.8. M+NZ2GF_ModuleWorkingInfoClr (Module operation information initialization)

FB Name

M+NZ2GF_ModuleWorkingInfoClr

Function Overview

Item	Description									
Function overview	Initializes the module operation information.									
Symbol	<div style="display: flex; align-items: center; justify-content: center;"> <div style="margin-right: 20px;"> <p>Execution command — B : FB_EN</p> <p>Module start XY address — W : i_Start_IO_No</p> <p>Station No. — W : i_Station_No</p> <p>Own station channel — W : i_CH_No</p> </div> <div style="border: 1px solid black; padding: 5px; text-align: center;"> <p>M+NZ2GF_ModuleWorkingInfoClr</p> <table style="width: 100%; border-collapse: collapse;"> <tr> <td style="width: 50%;">FB_ENO : B</td> <td style="width: 50%;">FB_ENO : B</td> </tr> <tr> <td>FB_OK : B</td> <td>FB_OK : B</td> </tr> <tr> <td>FB_ERROR : B</td> <td>FB_ERROR : B</td> </tr> <tr> <td>ERROR_ID : W</td> <td>ERROR_ID : W</td> </tr> </table> </div> <div style="margin-left: 20px;"> <p>— Execution status</p> <p>— Completed without error</p> <p>— Error flag</p> <p>— Error code</p> </div> </div>		FB_ENO : B	FB_ENO : B	FB_OK : B	FB_OK : B	FB_ERROR : B	FB_ERROR : B	ERROR_ID : W	ERROR_ID : W
FB_ENO : B	FB_ENO : B									
FB_OK : B	FB_OK : B									
FB_ERROR : B	FB_ERROR : B									
ERROR_ID : W	ERROR_ID : W									
Applicable hardware and software	CC-Link IE Field Network remote module	<table border="1" style="width: 100%; border-collapse: collapse;"> <thead> <tr> <th style="width: 30%;">Category</th> <th>Model</th> </tr> </thead> <tbody> <tr> <td>Analog</td> <td>NZ2GF2B-60AD4, NZ2GF2B-60DA4</td> </tr> <tr> <td>I/O</td> <td>NZ2GF2B1-16D, NZ2GF2B1-16T, NZ2GF2B1-16TE</td> </tr> <tr> <td>Counter</td> <td>NZ2GF2CF-D62PD2</td> </tr> </tbody> </table>	Category	Model	Analog	NZ2GF2B-60AD4, NZ2GF2B-60DA4	I/O	NZ2GF2B1-16D, NZ2GF2B1-16T, NZ2GF2B1-16TE	Counter	NZ2GF2CF-D62PD2
	Category	Model								
	Analog	NZ2GF2B-60AD4, NZ2GF2B-60DA4								
	I/O	NZ2GF2B1-16D, NZ2GF2B1-16T, NZ2GF2B1-16TE								
Counter	NZ2GF2CF-D62PD2									
CC-Link IE Field Network module	CC-Link IE Field Network master/local module *1 *1 The first five digits of the serial number are "14102" or later.									
CPU module	<table border="1" style="width: 100%; border-collapse: collapse;"> <thead> <tr> <th style="width: 30%;">Series</th> <th>Model</th> </tr> </thead> <tbody> <tr> <td>MELSEC-Q Series *1</td> <td>Universal model *2</td> </tr> <tr> <td>MELSEC-L Series</td> <td>LCPU *3</td> </tr> </tbody> </table> <p>*1 Not applicable to QCPU (A mode)</p> <p>*2 The first five digits of the serial number are "12012" or later.</p> <p>*3 The first five digits of the serial number are "13012" or later.</p>	Series	Model	MELSEC-Q Series *1	Universal model *2	MELSEC-L Series	LCPU *3			
Series	Model									
MELSEC-Q Series *1	Universal model *2									
MELSEC-L Series	LCPU *3									
Engineering software	GX Works2 *1 <table border="1" style="width: 100%; border-collapse: collapse;"> <thead> <tr> <th style="width: 30%;">Language</th> <th>Software version</th> </tr> </thead> <tbody> <tr> <td>English version</td> <td>Version1.24A or later</td> </tr> <tr> <td>Chinese version</td> <td>Version1.49B or later</td> </tr> </tbody> </table> <p>*1 For software versions applicable to the modules used, refer to "Relevant manuals".</p>	Language	Software version	English version	Version1.24A or later	Chinese version	Version1.49B or later			
Language	Software version									
English version	Version1.24A or later									
Chinese version	Version1.49B or later									

Item	Description
Programming language	Ladder
Number of steps	383 steps (for MELSEC-Q series universal model CPU) * The number of steps of the FB in a program depends on the CPU model that is used and input and output definition.
Function description	<ol style="list-style-type: none"> 1) By turning ON FB_EN (Execution command), the module operation information is initialized. 2) FB operation is one-shot only, triggered by the FB_EN signal. 3) When the CC-Link IE Field Network error occurs, the FB_ERROR output turns ON and processing is interrupted, and the error code is stored in ERROR_ID (Error code). Refer to the error code explanation section for details.
Compiling method	Macro type
Restrictions and precautions	<ol style="list-style-type: none"> 1) The FB does not include error recovery processing. Program the error recovery processing separately in accordance with the required system operation. 2) The FB cannot be used in an interrupt program. 3) This FB uses the REMFR and REMTO instructions. When operating this FB together with other FBs or using the REMFR or REMTO instruction in the ladder program, make sure that the channels used by the own station are not duplicated. 4) This FB uses index registers Z7 to Z9. Please do not use these index registers in an interrupt program. 5) This FB uses the transient transmission. An interlock program for the transient transmission is required. For the interlock program, refer to "1.4.1 Transient Transmission Interlock Program". 6) Every input must be provided with a value for proper FB operation.
FB operation type	Pulsed execution (multiple scan execution type)
Application example	Refer to "Appendix 1. FB Library Application Examples".
Timing chart	<div style="display: flex; justify-content: space-around;"> <div style="width: 45%;"> <p>[When operation completes without error]</p> </div> <div style="width: 45%;"> <p>[When an error occurs]</p> </div> </div>

Item	Description
Relevant manuals	CC-Link IE Field Network Analog-Digital Converter Module User's Manual CC-Link IE Field Network Digital-Analog Converter Module User's Manual CC-Link IE Field Network Remote I/O Module User's Manual CC-Link IE Field Network High-Speed Counter Module User's Manual MELSEC-Q CC-Link IE Field Network Master/Local Module User's Manual MELSEC-L CC-Link IE Field Network Master/Local Module User's Manual QCPU User's Manual (Hardware Design, Maintenance and Inspection) MELSEC-L CPU Module User's Manual (Hardware Design, Maintenance and Inspection) GX Works2 Version 1 Operating Manual (Common) GX Works2 Version 1 Operating Manual (Simple Project, Function Block)

Error codes

●Error code list

Error code	Description	Action
60 (Decimal)	The specified station number is not valid. The station number is not within the range of 1 to 120.	Please try again after confirming the setting.
D000 to DAF9 (Hexadecimal)	A CC-Link IE Field Network error has occurred.	For details, refer to the error code list of MELSEC-Q/MELSEC-L CC-Link IE Field Network Master/Local Module User's Manual.

Labels

●Input labels

Name (Comment)	Label name	Data type	Setting range	Description
Execution command	FB_EN	Bit	ON, OFF	ON: The FB is activated. OFF: The FB is not activated.
Module start XY address	i_Start_IO_No	Word	Depends on the I/O point range of the CPU. For details, refer to the CPU user's manual.	Specify the starting XY address (in hexadecimal) where the CC-Link IE Field Network master/local module is mounted or connected. (For example, enter H10 for X10.)
Station No.	i_Station_No	Word	1 to 120	Specify the station number of the target station.
Own station channel	i_CH_No	Word	1 to 32	Specify the channel for accessing other stations from the own station.

●Output labels

Name (Comment)	Label name	Data type	Initial value	Description
Execution status	FB_ENO	Bit	OFF	ON: Execution command is ON. OFF: Execution command is OFF.
Completed without error	FB_OK	Bit	OFF	When ON, it indicates that initializing the module operation information is completed.
Error flag	FB_ERROR	Bit	OFF	When ON, it indicates that an error has occurred.
Error code	ERROR_ID	Word	0	FB error code output.

FB Version Upgrade History

Version	Date	Description
1.00A	2013/07/15	First edition

Note

This chapter includes information related to the function block.

It does not include information on restrictions of use such as combination with modules or programmable controller CPUs.

Please make sure to read user's manuals for the corresponding products before using the products.

Appendix 1. FB Library Application Examples

CC-Link IE Field Network remote module FB application examples are as follows.

1) System configuration

(1) Q-series system configuration

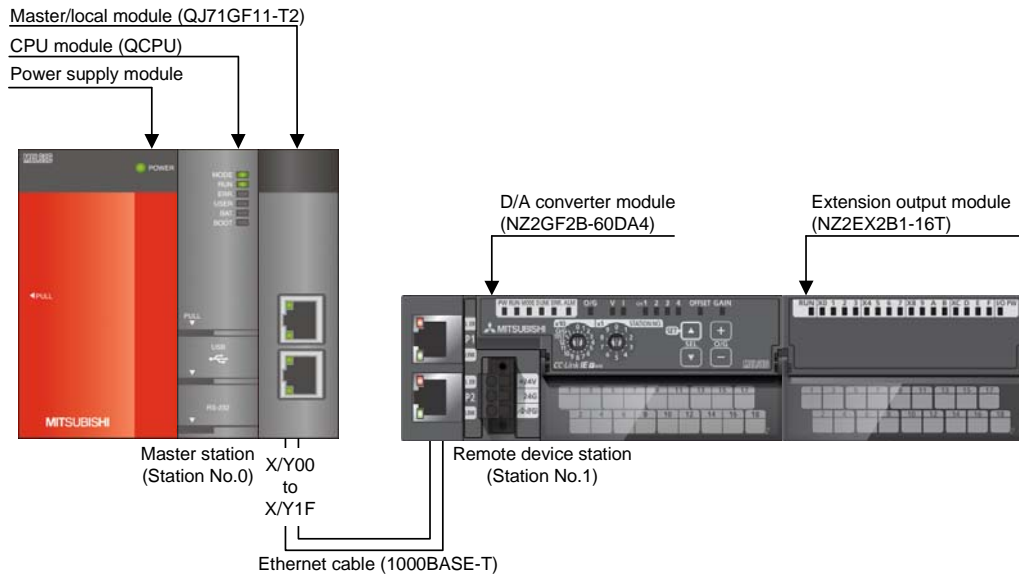

(2) L-series system configuration

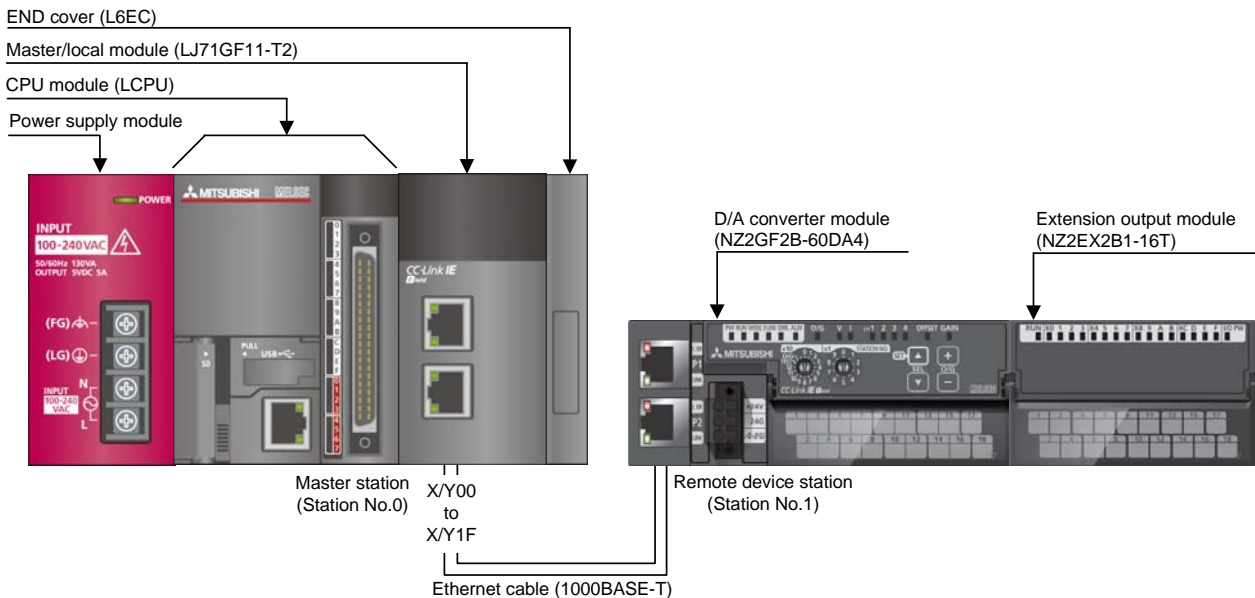

Reminder

- Every input must be provided with a value for proper FB operation.
If not set, the values will be unspecified.
- Abbreviations may be used in the label comments due to the limitation on the number of the characters to display in GX Works2.

Interlock program

* The following is an example of an interlock program.

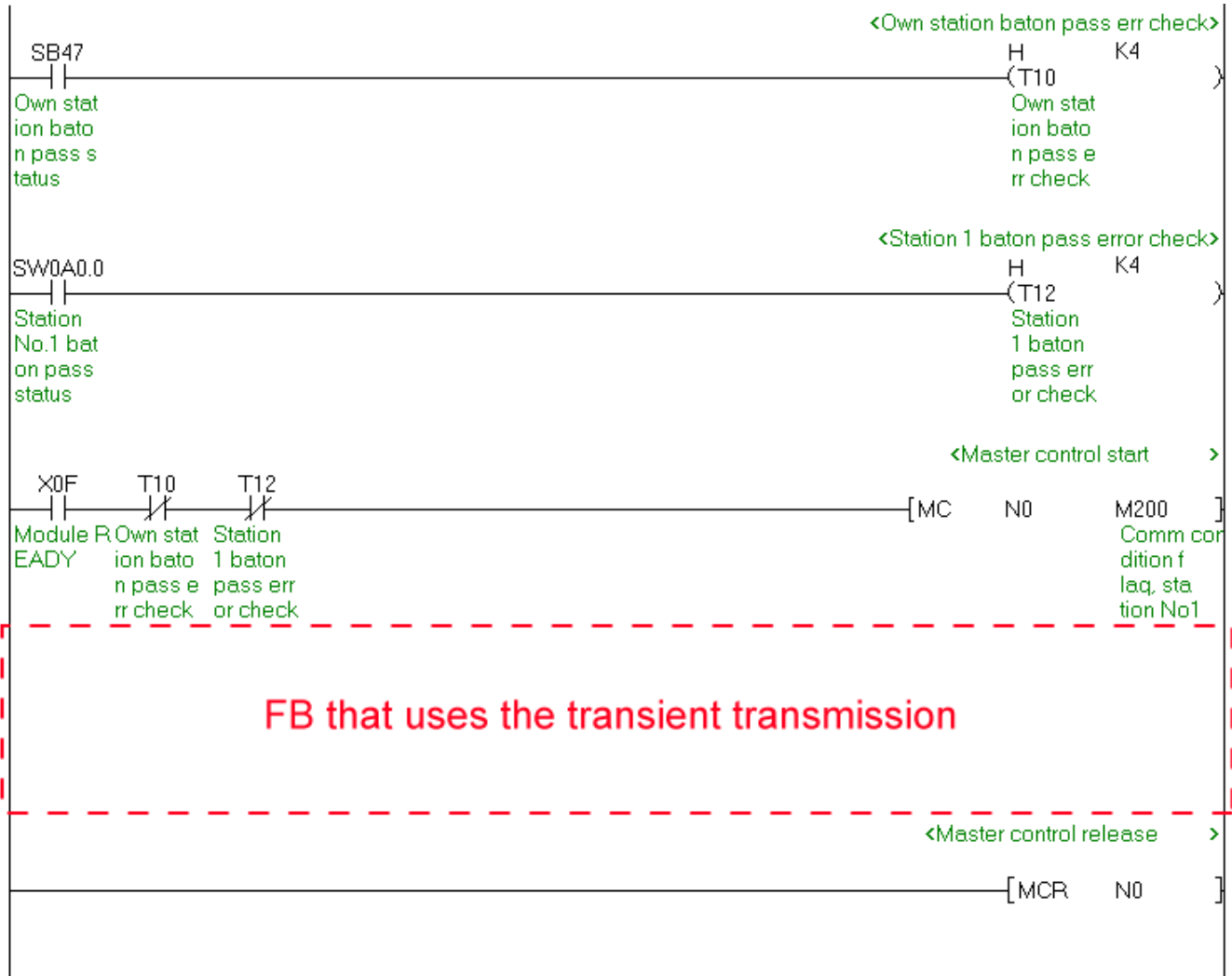

2) List of devices

a) External input (commands)

Device	FB name	Application (ON details)
M0	M+NZ2GF_ReadRemoteBufMemory	Remote buffer memory read req.
M10	M+NZ2GF_WriteRemoteBufMemory	Remote buffer memory write req.
D10		Write data
M20	M+NZ2GF_ReadExtModuleCode	Extension module ID read req.
M30	M+NZ2GF_ReadOutputOnTimes	No. of ON integrate val read req
M70	M+NZ2GF_OutputOnTimesTotalClr	No. of ON integrate val clr req.
M80	M+NZ2GF_ParameterInfoClr	Parameter info. initialize req.
M90	M+NZ2GF_ErrorHistoryClr	Error history clear request
M100	M+NZ2GF_ModuleWorkingInfoClr	Module ope info. initialize req.

b) External output (checks)

Device	FB name	Application (ON details)
M1	M+NZ2GF_ReadRemoteBufMemory	Remote buffer memory read ready
M2		Remote buffer memory read comp.
D0		Read data
F0		Buffer memory read FB error
D1		Buffer memory read FB error code
M11	M+NZ2GF_WriteRemoteBufMemory	Remote buffer memory write ready
M12		Remote buffer memory write comp.
F5		Buffer memory write FB error
D11		Buffer memory write FB err code
M21	M+NZ2GF_ReadExtModuleCode	Extension module ID read ready
M22		Extension module ID read comp.
D20		Points of extension module
D21		Extension module type
F10		ID code read FB error
D22		ID code read FB error code
M31	M+NZ2GF_ReadOutputOnTimes	No. of ON integrate val read rdy
M32		No. of ON integrate val read com
D30 to D61		No. of ON integration value
F15		No. of ON times read FB error
D62		No. of ON times read FB err code
M71	M+NZ2GF_OutputOnTimesTotalClr	No. of ON integrate val clr rdy.
M72		No. of ON integrate val clr comp
F20		No. of ON times clear FB error
D70		No. of ON times clear FB err cod
M81	M+NZ2GF_ParameterInfoClr	Parameter info. initialize rdy.
M82		Parameter info. initialize comp.
F25		Parameter information FB error
D80		Parameter info. FB error code
M91	M+NZ2GF_ErrorHistoryClr	Error history clear ready
M92		Error history clear complete
F30		Error history clear FB error
D90		Error history clear FB err code

Device	FB name	Application (ON details)
M101	M+NZ2GF_ModuleWorkingInfoClr	Module ope info. initialize rdy.
M102		Module ope info. initialize comp
F35		Module operate info. FB error
D100		Module operate info FB err code

3) Global label setting

None

4) Programs

M+NZ2GF_ReadRemoteBufMemory (Read remote buffer memory)

The following shows the example program with the conditions described in the table below.

Label name	Setting value	Description
i_Start_IO_No	H0	Set the starting XY address where the CC-Link IE Field Network master/local module is mounted or connected to 0H.
i_Station_No	K1	Set the station number of the target station to 1.
i_CH_No	K1	Set the own station channel to 1.
i_Address	H600	Set the starting address (in hexadecimal) of the remote buffer memory from which the value is read to 600H.
i_ReadPoint	K1	Set the reading points to 1.

By turning ON M0, the value of the specified remote buffer memory is read.

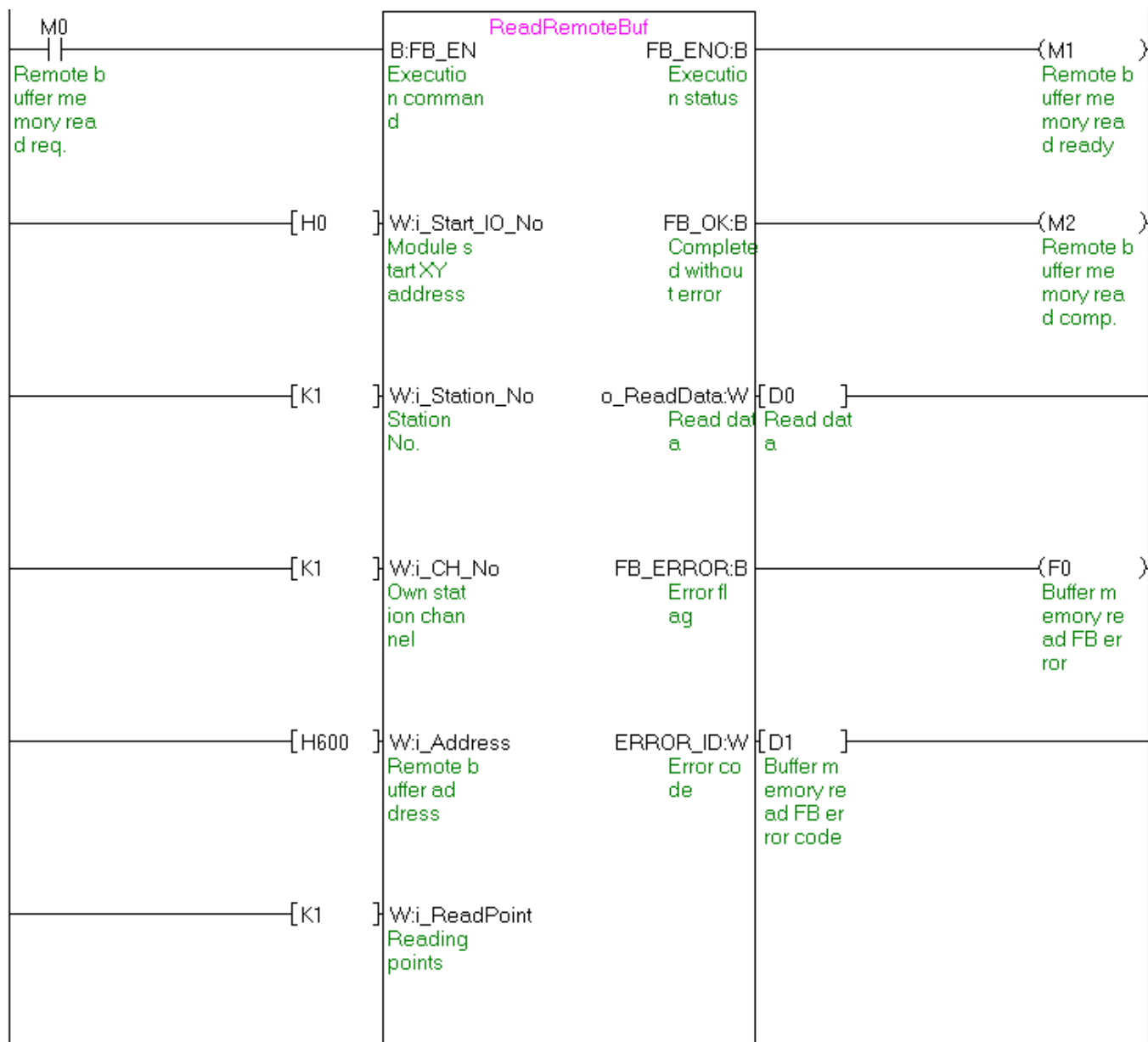

M+NZ2GF_WriteRemoteBufMemory (Write remote buffer memory)

The following shows the example program with the conditions described in the table below.

Label name	Setting value	Description
i_Start_IO_No	H0	Set the starting XY address where the CC-Link IE Field Network master/local module is mounted or connected to 0H.
i_Station_No	K1	Set the station number of the target station to 1.
i_CH_No	K1	Set the own station channel to 1.
i_Address	H0	Set the starting address (in hexadecimal) of the remote buffer memory to which the value is written to 0H.
i_WritePoint	K1	Set the writing points to 1.
i_WriteData	D10	Set the start device of devices that have the values to be written to D10.

By turning ON M10, the value is written to specified remote buffer memory.

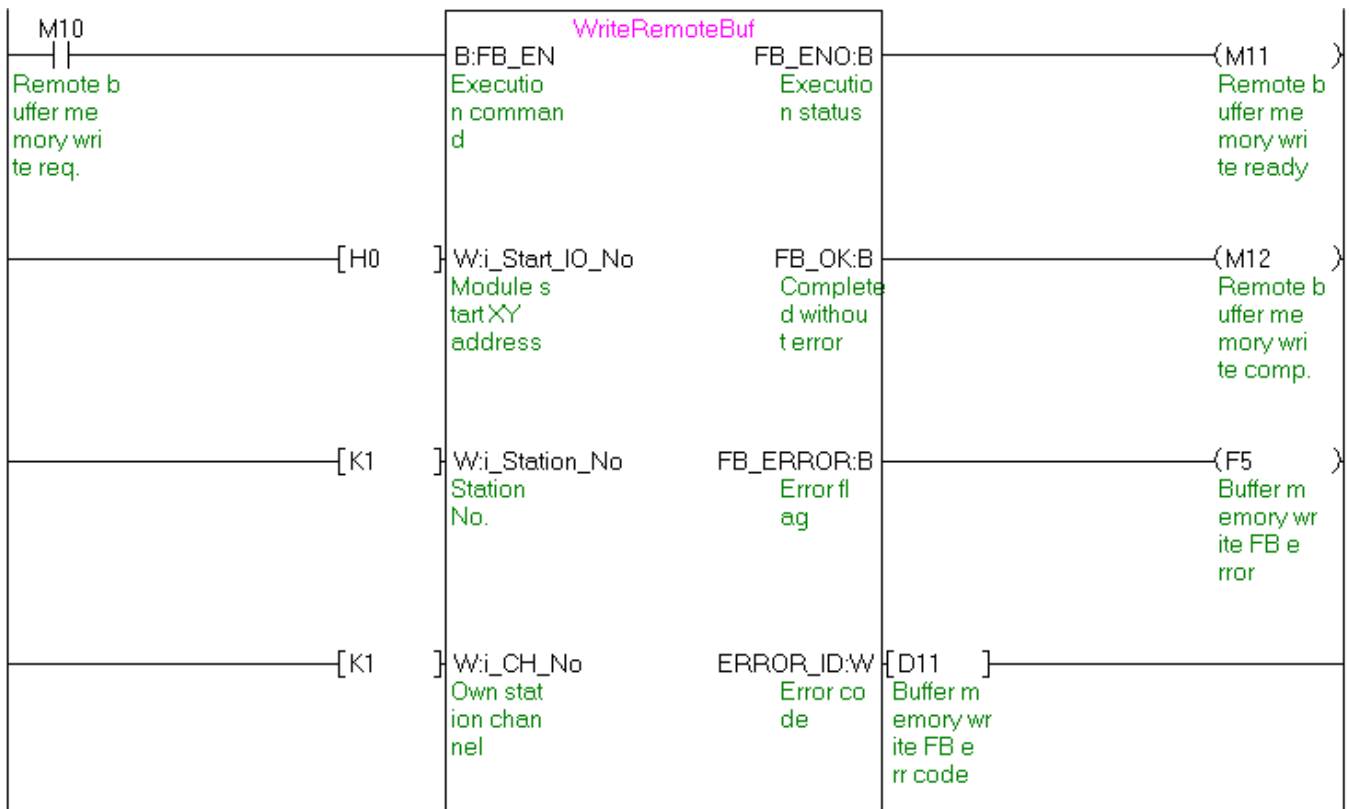

(Continues to the next page)

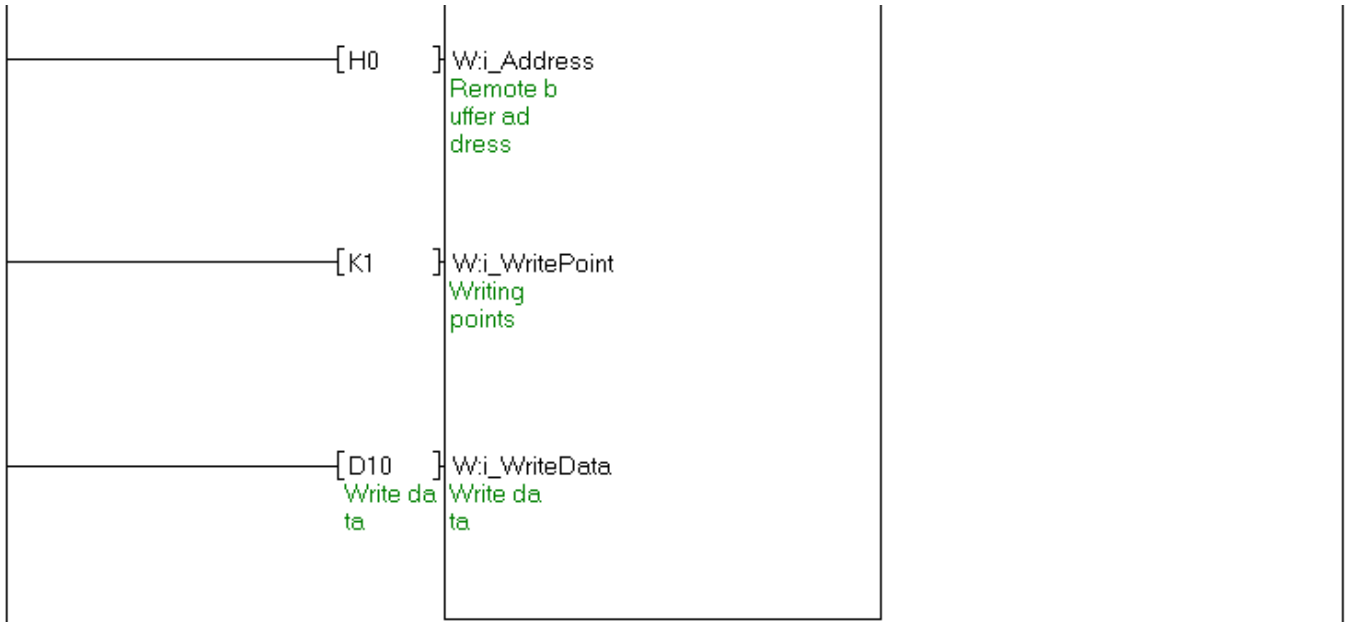

M+NZ2GF_ReadExtModuleCode (Read extension module identification code)

The following shows the example program with the conditions described in the table below.

Label name	Setting value	Description
i_Start_IO_No	H0	Set the starting XY address where the CC-Link IE Field Network master/local module is mounted or connected to 0H.
i_Station_No	K1	Set the station number of the target station to 1.
i_CH_No	K1	Set the own station channel to 1.
i_ExtensionNo	K1	Set the extension module number to 1.

By turning ON M20, the identification code of the specified extension module is read.

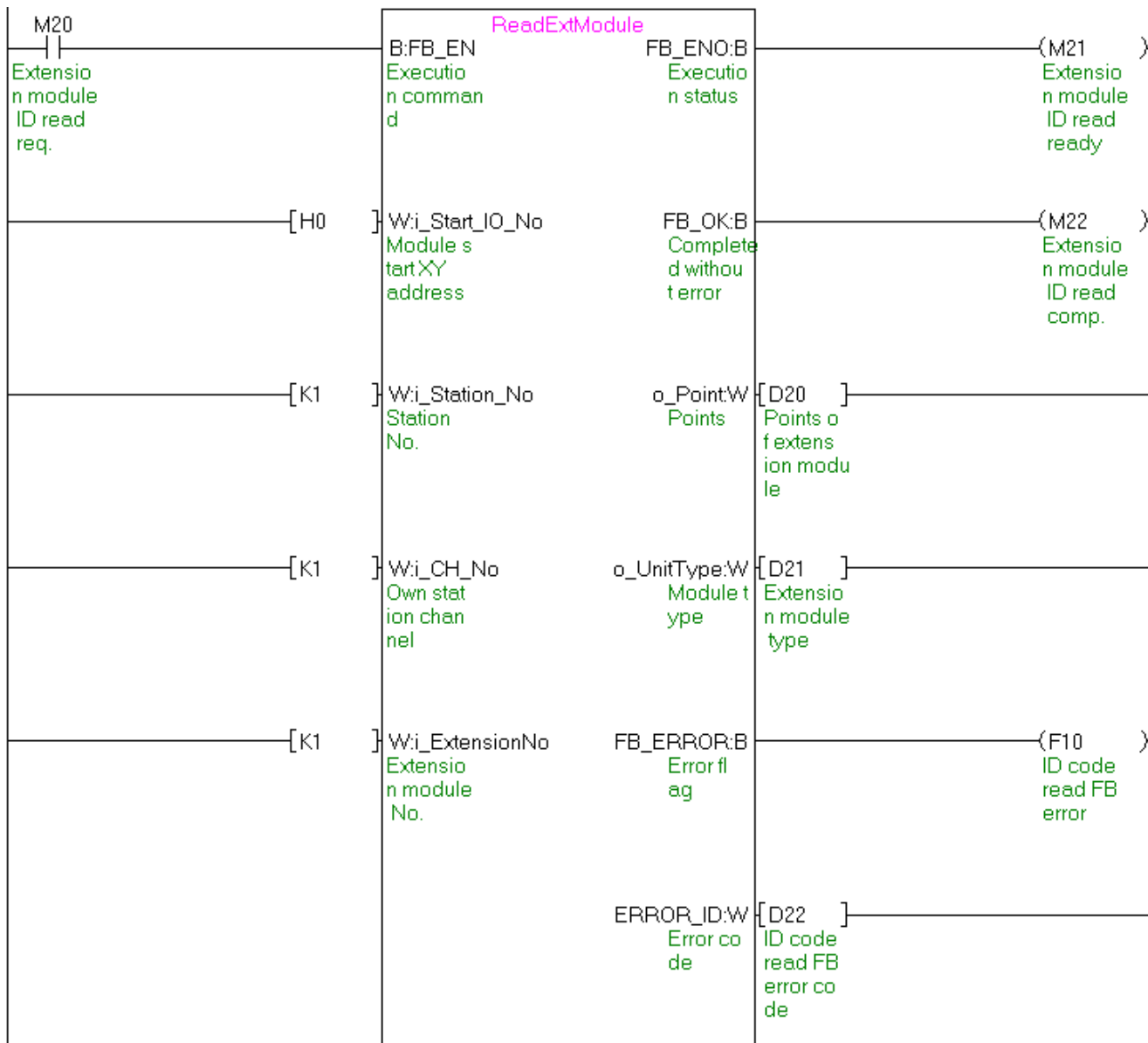

M+NZ2GF_ReadOutputOnTimes (Read number of ON times integration value)

The following shows the example program with the conditions described in the table below.

Label name	Setting value	Description
i_Start_IO_No	H0	Set the starting XY address where the CC-Link IE Field Network master/local module is mounted or connected to 0H.
i_Station_No	K1	Set the station number of the target station to 1.
i_CH_No	K1	Set the own station channel to 1.
i_ExtensionNo	K1	Set the extension module number to 1.

By turning ON M30, the number of ON times integration values Y0 to YF are read.

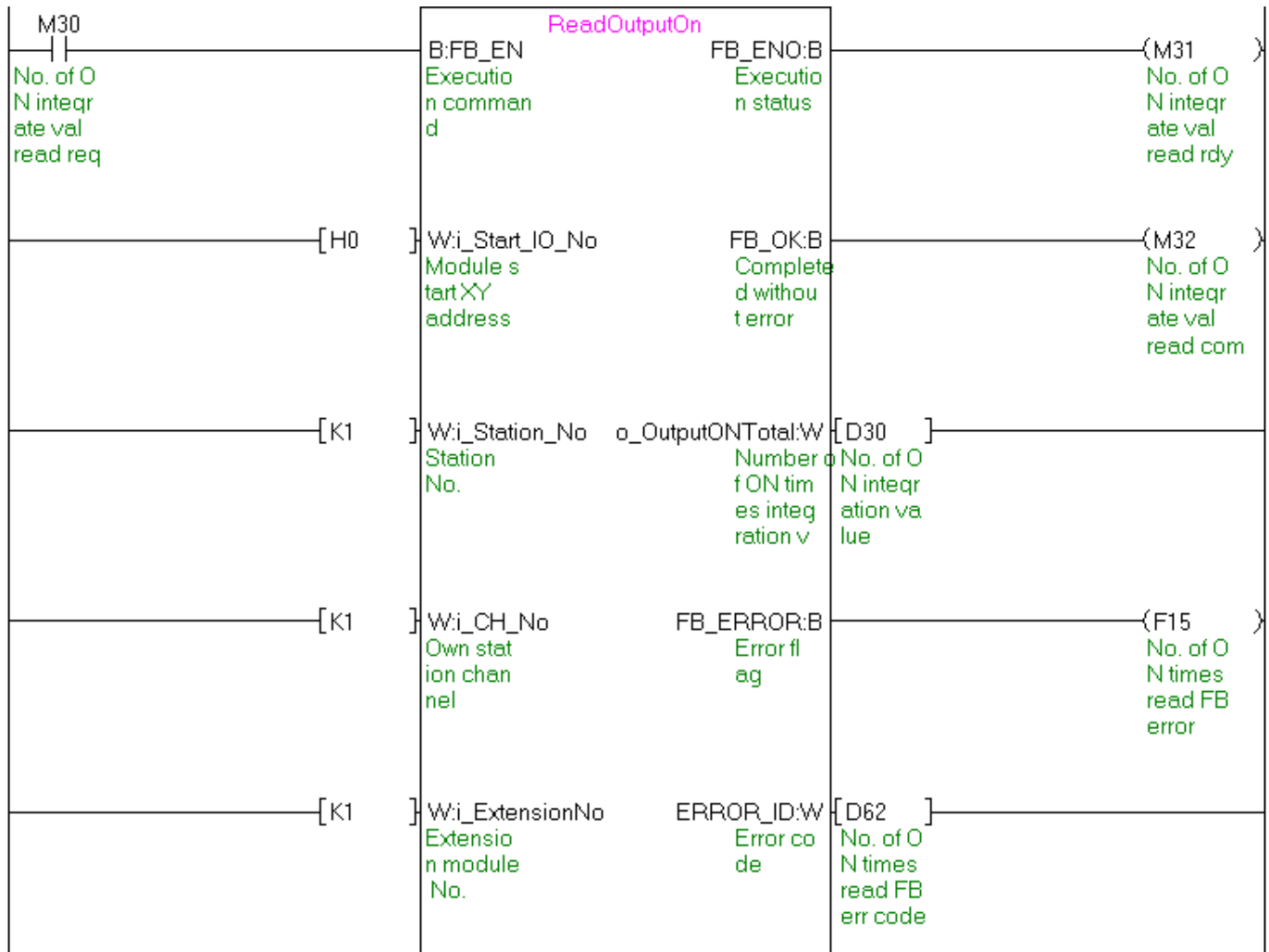

M+NZ2GF_OutputOnTimesTotalClr (Number of ON times integration value clear)

The following shows the example program with the conditions described in the table below.

Label name	Setting value	Description
i_Start_IO_No	H0	Set the starting XY address where the CC-Link IE Field Network master/local module is mounted or connected to 0H.
i_Station_No	K1	Set the station number of the target station to 1.
i_CH_No	K1	Set the own station channel to 1.
i_ExtensionNo	K1	Set the extension module number to 1.
i_OutputClrSlct	H1	Set the range to clear the number of ON times integration value to 1H.

By turning ON M70, the number of ON times integration values Y0 to YF are cleared.

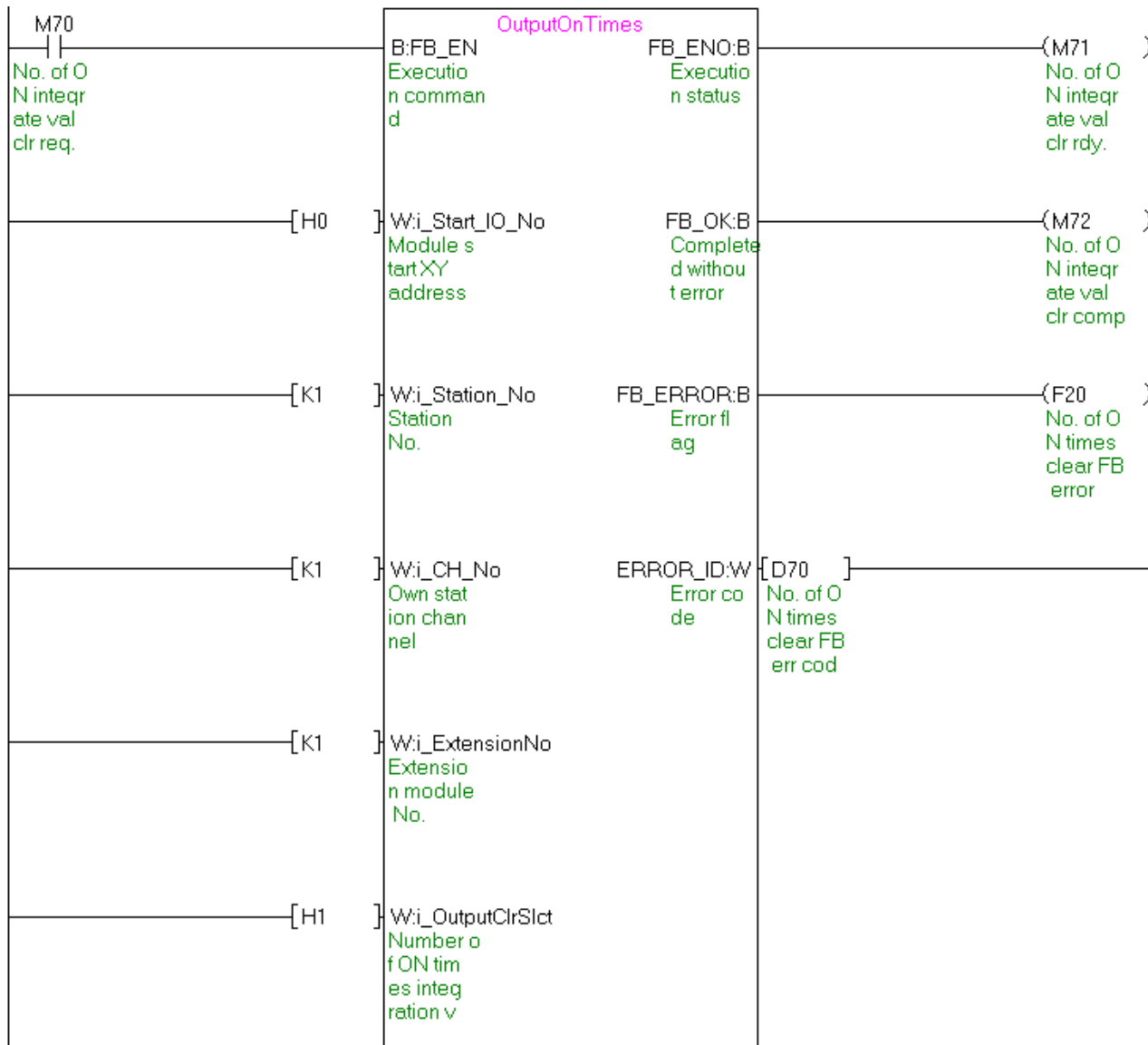

M+NZ2GF_ParameterInfoClr (Parameter information initialization)

The following shows the example program with the conditions described in the table below.

Label name	Setting value	Description
i_Start_IO_No	H0	Set the starting XY address where the CC-Link IE Field Network master/local module is mounted or connected to 0H.
i_Station_No	K1	Set the station number of the target station to 1.
i_CH_No	K1	Set the own station channel to 1.

By turning ON M80, the parameter information is initialized.

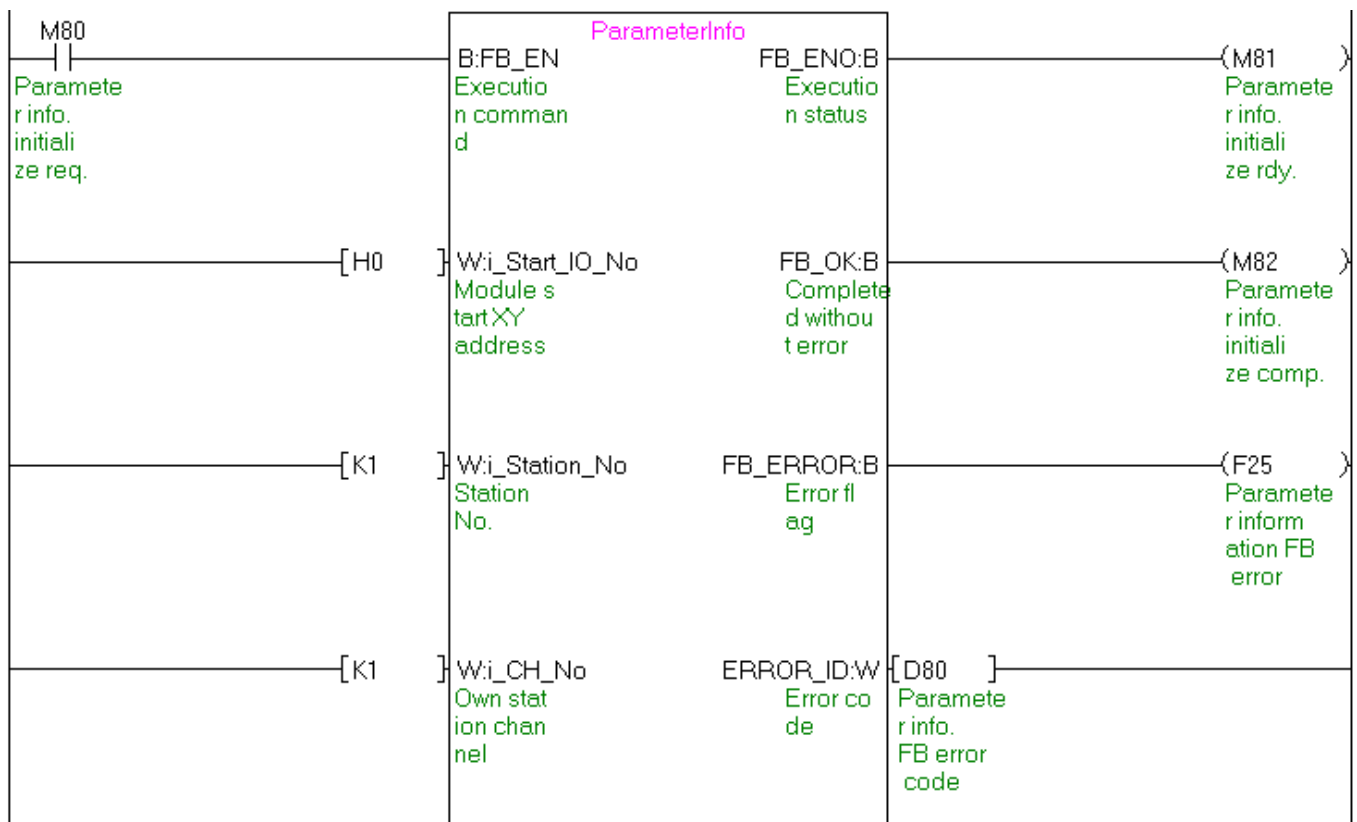

M+NZ2GF_ErrorHistoryClr (Error history clear)

The following shows the example program with the conditions described in the table below.

Label name	Setting value	Description
i_Start_IO_No	H0	Set the starting XY address where the CC-Link IE Field Network master/local module is mounted or connected to 0H.
i_Station_No	K1	Set the station number of the target station to 1.
i_CH_No	K1	Set the own station channel to 1.

By turning ON M90, the error history is cleared.

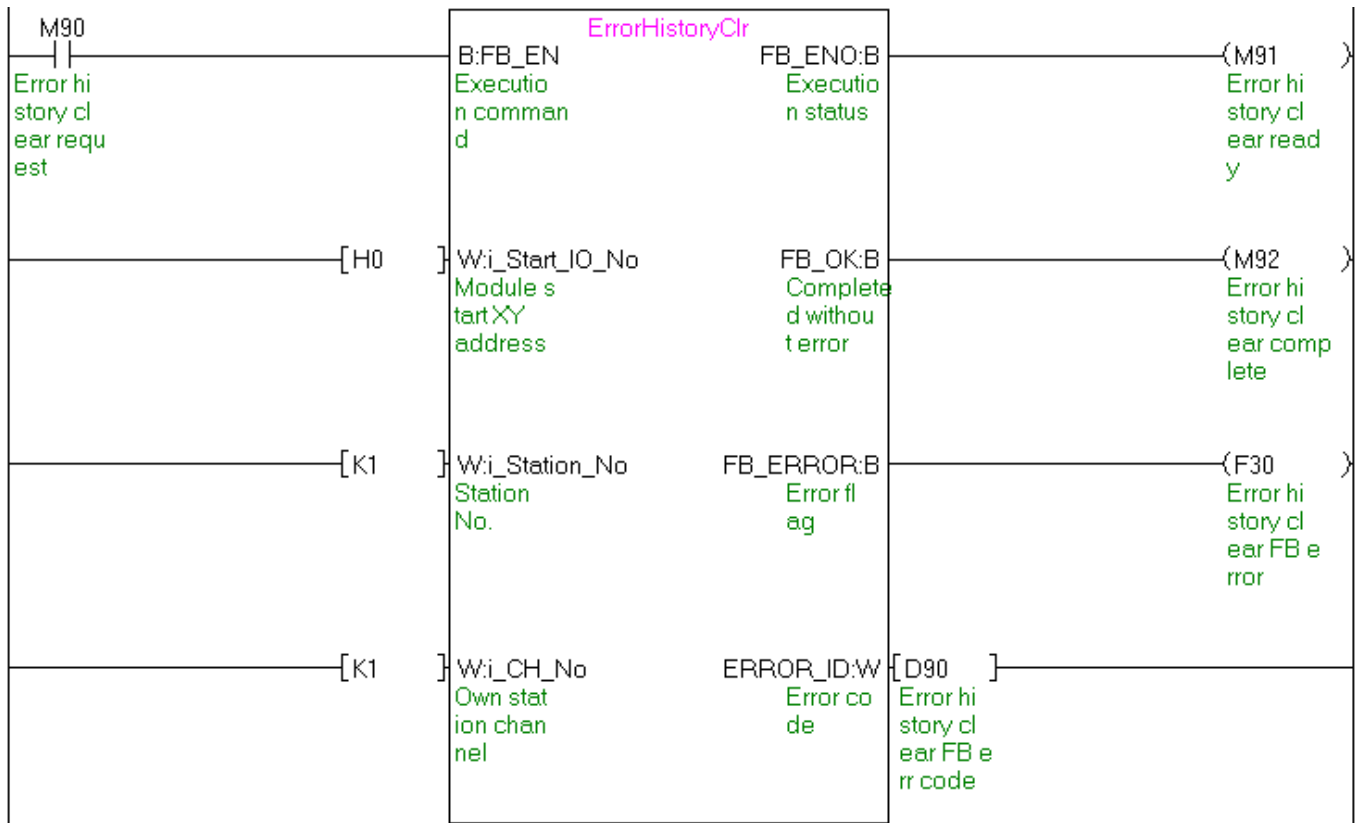

M+NZ2GF_ModuleWorkingInfoClr (Module operation information initialization)

The following shows the example program with the conditions described in the table below.

Label name	Setting value	Description
i_Start_IO_No	H0	Set the starting XY address where the CC-Link IE Field Network master/local module is mounted or connected to 0H.
i_Station_No	K1	Set the station number of the target station to 1.
i_CH_No	K1	Set the own station channel to 1.

By turning ON M100, the parameter information is initialized.

